

# Service Manual

**PIONEER®**  
The Art of Entertainment

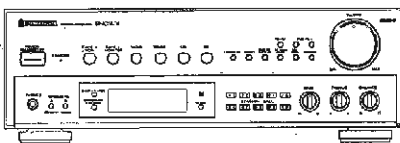

The illustration shows model SX-403RDS.

ORDER NO.  
ARP2859

STEREO RECEIVER

# SX-403RDS

## SX-303RDS

## SX-203RDS

THIS MANUAL IS APPLICABLE TO THE FOLLOWING MODEL(S) AND TYPE(S).

Type	Model			Power Requirement	The voltage can be converted by the following method.
	SX-403RDS	SX-303RDS	SX-203RDS		
HEXK	○	○	○	AC220-230V	AC240V, *
HBXK	—	○	○	AC240V	AC220-230V, *
HEWZXX	○	○	○	AC220-230V	AC240V, *

\*: Alter the wiring of the Power-supply block at the primary winding of Power transformer referring to the "Line Voltage Selection" described in Service Manual.

- For the following: SX-403RDS/HEWZXX; SX-303RDS/HBXK and HEWZXX; SX-203/HBXK and HEWZXX, refer to page 40.

## CONTENTS

1. EXPLODED VIEWS, PACKING AND PARTS LIST .....	2	6. FL INFORMATION .....	37
2. BLOCK DIAGRAM .....	5	7. IC INFORMATION .....	38
3. SCHEMATIC AND PCB CONNECTION DIAGRAMS .....	6	8. FOR SX-403RDS/HEWZXX, SX-303RDS/HBXK, HEWZXX, SX-203/HBXK AND HEWZXX TYPES ...	40
4. PCB PARTS LIST .....	31	9. PANEL FACILITIES .....	44
5. ADJUSTMENTS .....	35	10. SPECIFICATIONS .....	47

**PIONEER ELECTRONIC CORPORATION** 4-1, Meguro 1-Chome, Meguro-ku, Tokyo 153, Japan  
**PIONEER ELECTRONICS SERVICE INC.** P.O. Box 1760, Long Beach, California 90801 U.S.A.  
**PIONEER ELECTRONICS OF CANADA, INC.** 300 Allstate Parkway Markham, Ontario L3R 0P2 Canada  
**PIONEER ELECTRONIC [EUROPE] N.V.** Haven 1087 Keetberglaan 1, 9120 Melsele, Belgium  
**PIONEER ELECTRONICS AUSTRALIA PTY. LTD.** 178-184 Boundary Road, Braeside, Victoria 3195, Australia TEL: [03] 580-9911  
 © PIONEER ELECTRONIC CORPORATION 1994

O-DFO MAY 1994 Printed in Japan

# SX-403RDS, SX-303RDS, SX-203RDS

## 1. EXPLODED VIEWS, PACKING AND PARTS LIST

### NOTES :

- Parts marked by "NSP" are generally unavailable because they are not in our Master Spare Parts List.
- The  $\Delta$  mark found on some component parts indicates the importance of the safety factor of the part. Therefore, when replacing, be sure to use parts of identical designation.
- Parts marked by "⊙" are not always kept in stock. Their delivery time may be longer than usual or they may be unavailable.

### Parts List of Exterior and Packing

(For SX-403RDS/HEXK, SX-303RDS/HEXK and SX-203RDS/HEXK)

Mark	No.	Description	Parts No.	Mark	No.	Description	Parts No.
	1	SUB PANEL (PLS)	AAP1465	21	SCREW (For SX-403RDS)	VCT30P080FZK	
	2	FRONT PANEL (PLS) (For SX-403RDS)	AMB2222	21	SCREW (For SX-303RDS and SX-203RDS)	BCZ30P080FZK	
	2	FRONT PANEL (PLS) (For SX-303RDS)	AMB2226	22	SCREW (STEEL)	ABA1047	
	2	FRONT PANEL (PLS) (For SX-203RDS)	AMB2227	23	SCREW	ABA1054	
$\Delta$	3	TRANSISTOR (Q3, Q4) (For SX-403RDS)	2SA1302	24	SCREW (STEEL)	ABA1095	
$\Delta$	3	POWER TRANSISTOR (Q3, Q4) (For SX-303RDS)	2SA1804	25	SCREW (STEEL)	ABA1194	
$\Delta$	3	POWER TRANSISTOR (Q3, Q4) (For SX-203RDS)	2SA1803	26	SCREW	BBZ30P080FMC	
$\Delta$	4	TRANSISTOR (Q1, Q2) (For SX-403RDS)	2SC3281	27	SCREW	BBZ30P200FMC	
$\Delta$	4	POWER TRANSISTOR (Q1, Q2) (For SX-303RDS)	2SC4689	28	SCREW	BCZ30P080FZK	
$\Delta$	4	POWER TRANSISTOR (Q1, Q2) (For SX-203RDS)	2SC4688	29	SCREW	BPZ26P080FMC	
	5	CERAMIC CAPACITOR (C1)	CKDYB102K50	30	NUT (SX-203RDS only)	NK90FUC	
$\Delta$	6	POWER TRANSFORMER (T1) (For SX-403RDS)	ATS1544	31	IR FILTER (PLS) (SX-403RDS and SX-303RDS only)	AAK2551	
$\Delta$	6	POWER TRANSFORMER (T1) (For SX-303RDS)	ATS1543	32	LED LENS (PLS)	AAK2553	
$\Delta$	6	POWER TRANSFORMER (T1) (For SX-203RDS)	ATS1542	33	FL PANEL (PLS) (For SX-403RDS and SX-303RDS)	AAK2556	
$\Delta$	7	FUSE (T800MA/250V, FU3, FU4)	AEK-507	33	FL PANEL (PLS) (For SX-203RDS)	AAK2557	
$\Delta$	8	FUSE (T2A/250V, FU1) (For SX-403RDS)	AEK-511	34	NAME PLATE	PAM1608	
$\Delta$	8	FUSE (T1.6A/250V, FU1) (For SX-303RDS)	AEK-510	35	ROUND KNOB S (PLS)	AAB1389	
$\Delta$	8	FUSE (1.25A/250V, FU1) (For SX-203RDS)	AEK-509	36	ROUND KNOB L (PLS)	AAB1390	
$\Delta$	9	AC POWER CORD	ADG1135	37	PUSH BUTTON (PLS)	AAD2530	
NSP	10	CHASSIS (MET)	ANA1481	38	POWER BUTTON (PLS)	AAD2531	
	11	REAR PANEL (MET) (For SX-403RDS)	ANC2213	39	STATION BUTTON (PLS)	AAD2532	
	11	REAR PANEL (MET) (For SX-303RDS)	ANC2164	40	HINGE BUTTON (PLS) (For SX-403RDS)	AAD2534	
	11	REAR PANEL (MET) (For SX-203RDS)	ANC2165	40	HINGE BUTTON (PLS) (For SX-303RDS and SX-203RDS)	AAD2533	
NSP	12	RADIATOR (MET) (For SX-403RDS)	ANH1475	41	PUSH BUTTON (PLS)	AAD2535	
NSP	12	RADIATOR (MET) (For SX-303RDS)	ANH1476	42	BONNET CASE (MET)	ANE1502	
NSP	12	RADIATOR (MET) (For SX-203RDS)	ANH1477	43	OPERATING INSTRUCTIONS (English, French, German, Italian, Dutch, Swedish, Spanish, Portuguese)	ARE1312	
	13	INSULATOR	PNW1912	44	REMOTE CONTROL UNIT (CU-SX087) (SX-403RDS and SX-303RDS only)	AXD1397	
	14	HOLDER (MTL)	ANG1928	45	BATTERY COVER (SX-403RDS and SX-303RDS only)	AZA7031	
	15	SPRING (FE)	ABH1095	NSP 46	BATTERY (R6P, AA) (SX-403RDS and SX-303RDS only)	AEX-010	
	16	PCB SUPPORT	AEC1581	47	FM ANTENNA ASS'Y	ADH1019	
	17	SHEET (SX-403RDS only)	AEB1014	48	.....		
	18	BINDER	AEP-215	49	LOOP ANTENNA (L8042)	ATB1011	
	19	PCB MOLD (PP)	AMR2533	50	PAD SIDE A (PAP)	AHA2009	
NSP	20	BINDER (BK-1)	Z09-057				

Mark	No.	Description	Parts No.
	51	PAD SIDE B (L) (PAP)	AHA2010
	52	PAD SIDE B (R) (PAP)	AHA2011
	53	PACKING CASE (PAP) (For SX-403RDS)	AHD2719
	53	PACKING CASE (PAP) (For SX-303RDS)	AHD2720
	53	PACKING CASE (PAP) (For SX-203RDS)	AHD2721
	54	PACKAGING SHEET	AHG1215
	55	AF ASSY (For SX-403RDS)	AWZ5488
	55	AF ASSY (For SX-303RDS)	AWZ5484
	55	AF ASSY (For SX-203RDS)	AWZ5476
	56	FRONT ASSY (For SX-403RDS)	AWZ5489
	56	FRONT ASSY (For SX-303RDS)	AWZ5485
	56	FRONT ASSY (For SX-203RDS)	AWZ5477
	57	VR ASSY (For SX-403RDS)	AWZ5502
	57	VR ASSY (For SX-303RDS)	AWZ5486
	58	TRANS ASSY	AWZ5480
	59	SP SW ASSY	AWZ5478
	60	RDS ASSEMBLY	AWZ5479
	61	POWER SW ASSY (For SX-203RDS)	AWZ5481
	62	FM/AM TUNER MODULE	AXQ3227

Note : No. 12 illustration shows SX-403RDS.

NOTE : Screws adjacent to ▼ mark on the product are used for disassembly.

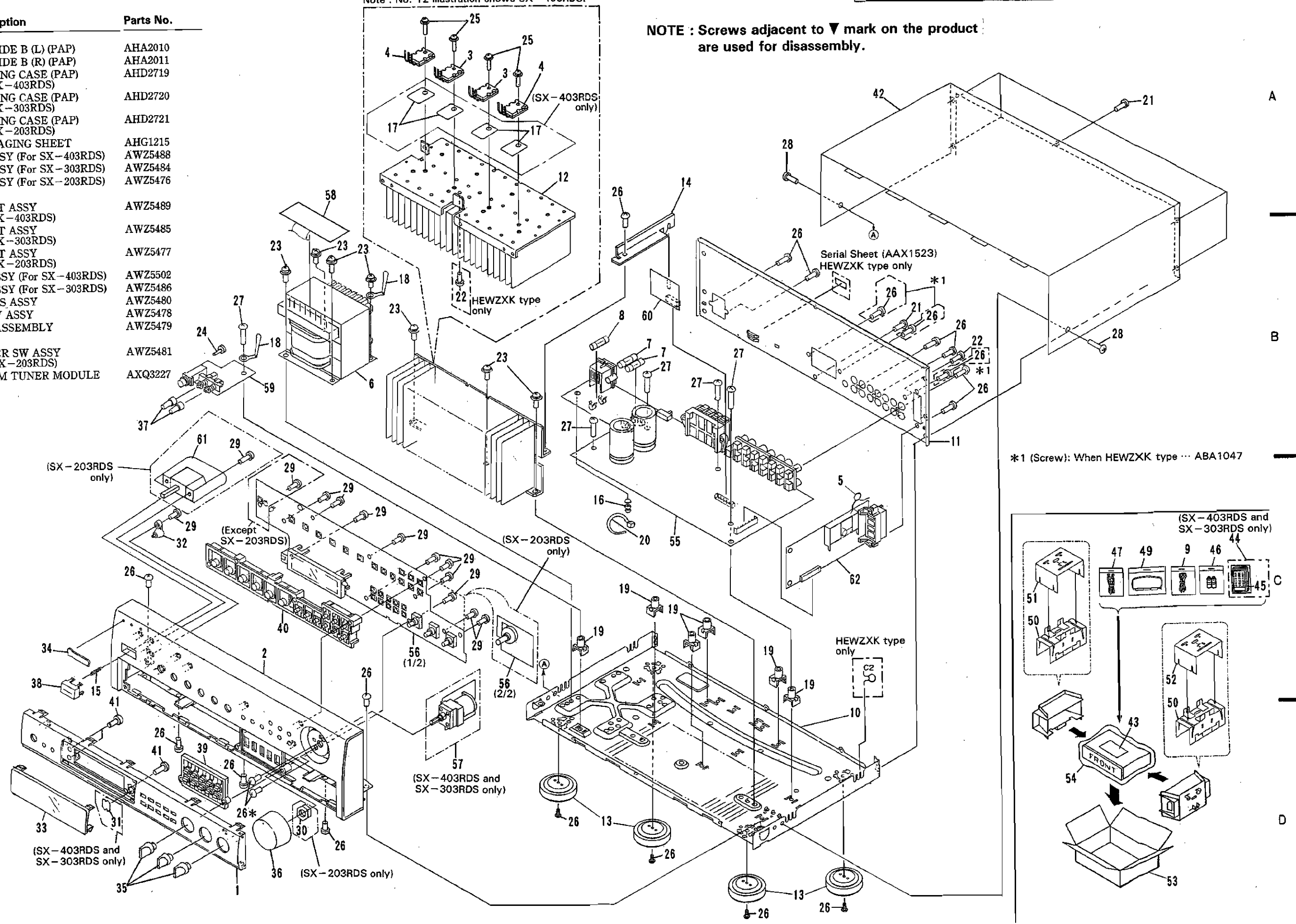

\* : SX-403RDS and SX-303RDS only

\*1 (Screw): When HEWZK type ... ABA1047

(SX-403RDS and SX-303RDS only)

2. BLOCK DIAGRAM

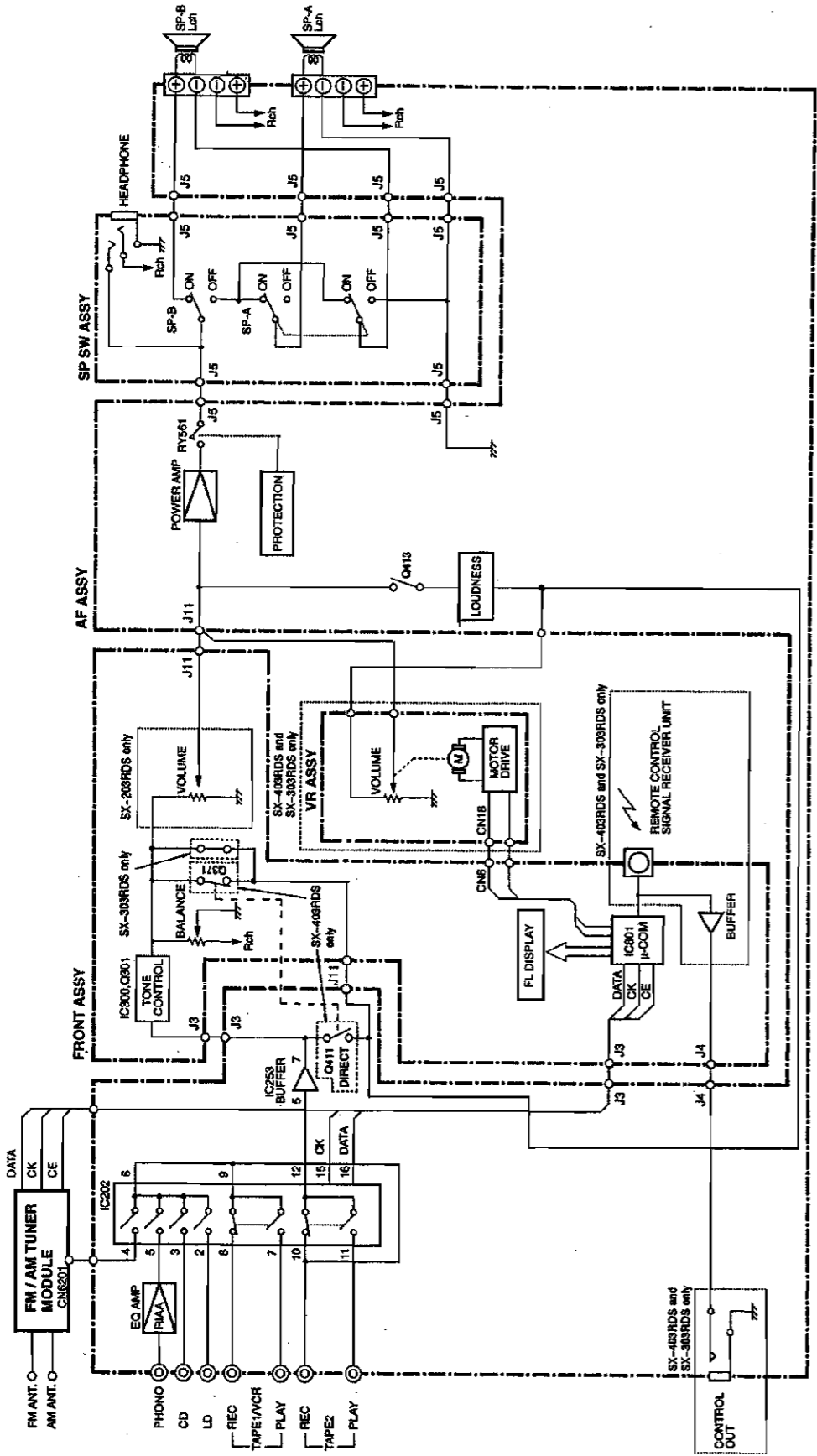

3. SCHEMATIC AND PCB CONNECTION DIAGRAMS

NOTE FOR SCHEMATIC DIAGRAMS Type 1A

- When ordering service parts, be sure to refer to "PARTS LIST of EXPLODED VIEWS" or "PCB PARTS LIST".
- Since these are basic circuits, some parts of them or the values of some components may be changed for improvement.
- RESISTORS:**  
Unit: k:kΩ, M:MΩ, or Ω unless otherwise noted.  
Rated power: 1/4W, 1/6W, 1/8W, 1/10W unless otherwise noted.  
Tolerance: (F): ±1%, (G): ±2%, (K): ±10%, (M): ±20% or ±5% unless otherwise noted.
- CAPACITORS:**  
Unit: p:pF or μF unless otherwise noted.  
Ratings: capacitor (μF)/ voltage (V) unless otherwise noted.  
Rated voltage: 50V except for electrolytic capacitors.
- COILS:**  
Unit: m:mH or μH unless otherwise noted.
- VOLTAGE AND CURRENT:**  
AF AMPLIFIER SECTION:  
V : Signal voltage at rated output.  
or - V :  
DC voltage (V) at no input signal unless otherwise noted.  
Value in ( ) is DC voltage at rated power.  
TUNER SECTION:  
mV : Signal voltage at FM 1kHz, 100% MOD.  
or - V :  
mA or - mA :  
DC current at no input signal unless otherwise noted.

NOTE FOR PCB DIAGRAMS:

- Part numbers in PCB diagrams match those in the schematic diagrams.
- A comparison between the main parts of PCB and schematic diagrams is shown below.

Symbol in PCB Diagrams	Symbol in Schematic Diagrams	Part Name
		Transistor
		Diode
		Capacitor (Polarized)

- The transistor terminal marked with E or □ shows the emitter.
- The diode terminal marked with ⊙ or C shows cathode side.
- The capacitor terminal marked with ⊙ or □ shows negative terminal.

- OTHERS:**
  - ⊙ or ● : Adjusting point.
  - ⊙ : Measurement point.
  - The Δ mark found on some component parts indicates the importance of the safety factor of the parts. Therefore, when replacing, be sure to use parts of identical designation.
- SCH-□ ON THE SCHEMATIC DIAGRAM:**
  - SCH-□ indicates the drawing number of the schematic diagram. (SCH stands for schematic diagram.)
- SWITCHES (Underline indicates switch position):**

FRONT assy			
S801	0	S816	LOUDNESS
S802	9	S817	TUNING +
S803	8	S818	TUNING -
S804	7	S819	FM/AM
S805	6	S820	CD
S806	5	S821	LD
S807	4	S822	TUNER
S808	3	S823	PHONO
S809	2	S824	TAPE2
S810	1	S825	TAPE1/VCR
S811	MEMORY	S826	RECEIVER
S812	MPX MODE	S827	CLASS
S813	MEMORY SCAN	S828	CHARACTER/SEARCH
S814	DIRECT ACCESS	S829	DISPLAY MODE
S815	DIRECT (SX-403RDS ONLY)		
S815	RF ATT (EXCEPT SX-403RDS)		

# SX-403RDS, SX-303RDS, SX-203RDS

## 3.1 OVERALL SCHEMATIC DIAGRAM

NOTE:

- The parts specified as "HEXK/HBXX TYPES" are required for the SX-403RDS/HEXK/HEXK and HBXX of SX-303RDS and SX-203RDS.
- The parts specified as "HBXX TYPE" are required for the HBXX of SX-303RDS and SX-203RDS.
- The parts specified as "HEWZXX TYPE" are required for the HEWZXX of SX-403RDS, SX-303RDS and SX-203RDS.
- The parts specified as "SX-403RDS" are required for the SX-403RDS/HEXK and HEWZXX.
- The parts specified as "SX-303RDS" are required for the SX-303RDS/HEXK, HBXX and HEWZXX.
- The parts specified as "SX-203RDS" are required for the SX-203RDS/HEXK, HBXX and HEWZXX.

### Line Voltage Selection

Line Voltage can be changed by the following modification:

1. Disconnect the AC power cord.
2. Remove the cover.
3. Change the connection of the power transformer primary taps.
4. Stick a line voltage label on the rear panel.

SCH-1

Part No.	Description
AAx-193	220V label
AAx-192	240V label

Part No.	Description
T1	ATS1542
FU1	AEK-509 (T1.25A)

Part No.	Description
T1	ATS1543
FU1	AEK-510 (T1.6A)

Part No.	Description
T1	ATS1544
FU1	AEK-511 (T2A)

Part No.	Description
T1	ATS1542
FU1	AEK-509 (T1.25A)

Part No.	Description
T1	ATS1543
FU1	AEK-510 (T1.6A)

Part No.	Description
T1	ATS1544
FU1	AEK-511 (T2A)

Part No.	Description
T1	ATS1542
FU1	AEK-509 (T1.25A)

Part No.	Description
T1	ATS1543
FU1	AEK-510 (T1.6A)

Part No.	Description
T1	ATS1544
FU1	AEK-511 (T2A)

Part No.	Description
T1	ATS1542
FU1	AEK-509 (T1.25A)

Part No.	Description
T1	ATS1543
FU1	AEK-510 (T1.6A)

Part No.	Description
T1	ATS1544
FU1	AEK-511 (T2A)

Part No.	Description
T1	ATS1542
FU1	AEK-509 (T1.25A)

Part No.	Description
T1	ATS1543
FU1	AEK-510 (T1.6A)

Part No.	Description
T1	ATS1544
FU1	AEK-511 (T2A)

Part No.	Description
T1	ATS1542
FU1	AEK-509 (T1.25A)

Part No.	Description
T1	ATS1543
FU1	AEK-510 (T1.6A)

Part No.	Description
T1	ATS1544
FU1	AEK-511 (T2A)

Part No.	Description
T1	ATS1542
FU1	AEK-509 (T1.25A)

Part No.	Description
T1	ATS1543
FU1	AEK-510 (T1.6A)

Part No.	Description
T1	ATS1544
FU1	AEK-511 (T2A)

Part No.	Description
T1	ATS1542
FU1	AEK-509 (T1.25A)

Part No.	Description
T1	ATS1543
FU1	AEK-510 (T1.6A)

Part No.	Description
T1	ATS1544
FU1	AEK-511 (T2A)

Part No.	Description
T1	ATS1542
FU1	AEK-509 (T1.25A)

Part No.	Description
T1	ATS1543
FU1	AEK-510 (T1.6A)

Part No.	Description
T1	ATS1544
FU1	AEK-511 (T2A)

Part No.	Description
T1	ATS1542
FU1	AEK-509 (T1.25A)

Part No.	Description
T1	ATS1543
FU1	AEK-510 (T1.6A)

Part No.	Description
T1	ATS1544
FU1	AEK-511 (T2A)

Part No.	Description
T1	ATS1542
FU1	AEK-509 (T1.25A)

Part No.	Description
T1	ATS1543
FU1	AEK-510 (T1.6A)

Part No.	Description
T1	ATS1544
FU1	AEK-511 (T2A)

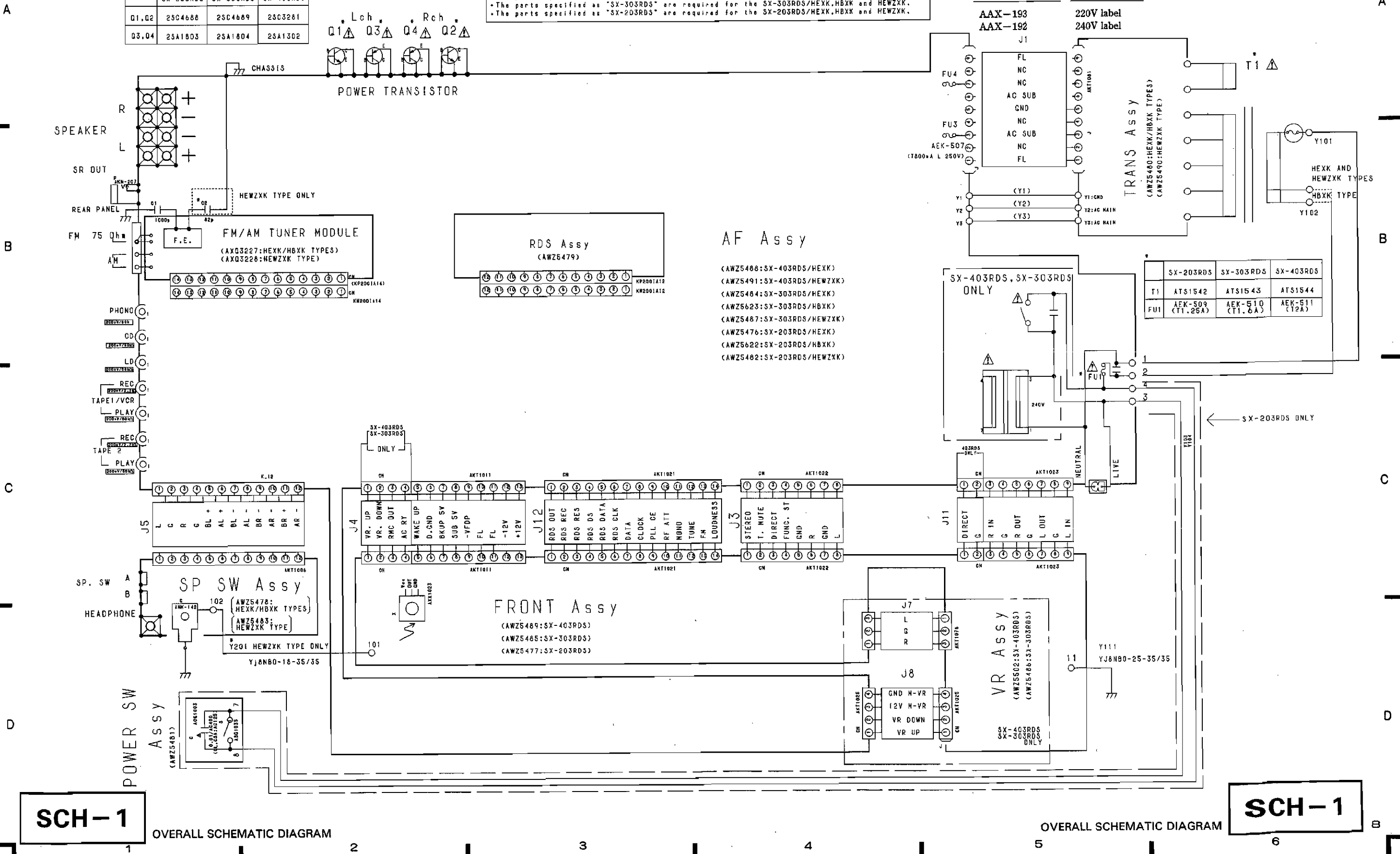

SCH-1

OVERALL SCHEMATIC DIAGRAM

SCH-1

OVERALL SCHEMATIC DIAGRAM

3.2 FM/AM TUNER MODULE

FM/AM TUNER MODULE  
(AXQ3227:HEXX and HBXX types)  
(AXQ3228:HEWZXX type)

Note:  
Value in ( ) is HEWZXX type.  
The parts specified as "HEXX and HBXX" are required for SX-403RDS/HEXX:HEXX and HBXX types of SX-303RDS and SX-203RDS.  
The parts specified as "HEWZXX" are required for HEWZXX type of SX-403RDS, SX-303RDS and SX-203RDS.

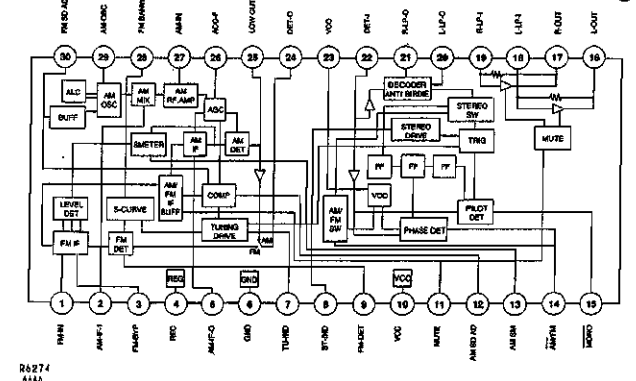

SCH-2

A

B

C

D

A

B

C

D

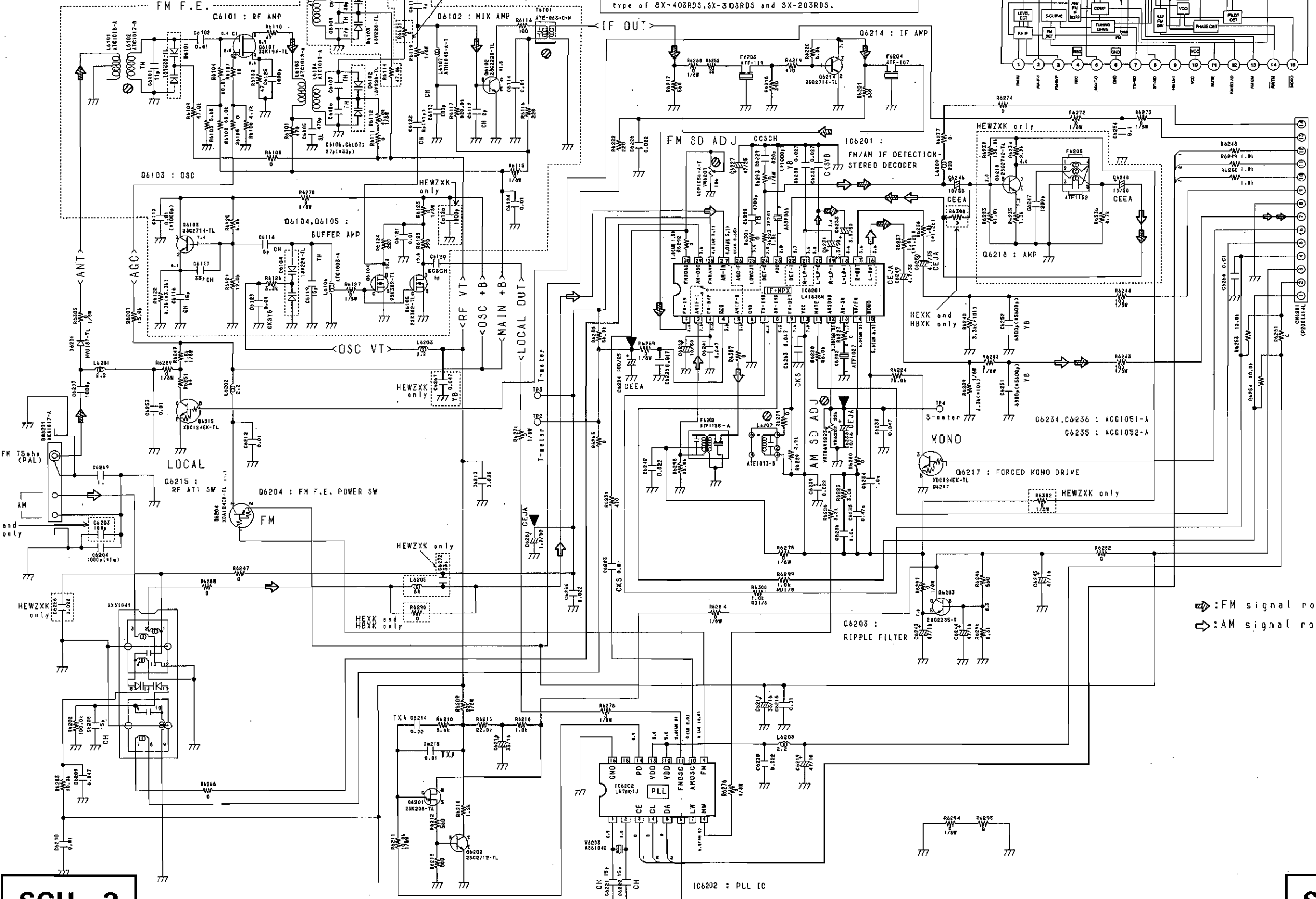

RDS LOCAL  
CE  
DA  
CL  
R CH  
GND  
L CH  
MONO  
MUTE  
TUNE  
+12V  
+5V  
STEREO

TO AF ASSY (→ SCH-3)

↗ : FM signal route  
↘ : AM signal route

SCH-2

FM/AM TUNER MODULE

SCH-2

FM/AM TUNER MODULE

Q6201, Q6202 : PLL LOOP FILTER DC AMP

IC66202 : PLL IC

Q6217 : FORCED MONO DRIVE

C6234, C6236 : ACC1051-A  
C6235 : ACC1052-A

MONO

Q6218 : AMP

HEWZXX only

HEXX and HBXX only

HEWZXX only

HEXX and HBXX only

HEWZXX only

HEXX and HBXX only

HEWZXX only

HEXX and HBXX only

HEWZXX only

HEXX and HBXX only

HEWZXX only

HEXX and HBXX only

HEWZXX only

HEXX and HBXX only

HEWZXX only

HEXX and HBXX only

HEWZXX only

HEXX and HBXX only

HEWZXX only

HEXX and HBXX only

HEWZXX only

HEXX and HBXX only

HEWZXX only

HEXX and HBXX only

HEWZXX only

HEXX and HBXX only

HEWZXX only

HEXX and HBXX only

HEWZXX only

HEXX and HBXX only

HEWZXX only

HEXX and HBXX only

HEWZXX only

HEXX and HBXX only

HEWZXX only

HEXX and HBXX only

HEWZXX only

HEXX and HBXX only

HEWZXX only

HEXX and HBXX only

HEWZXX only

HEXX and HBXX only

HEWZXX only

HEXX and HBXX only

HEWZXX only

HEXX and HBXX only

HEWZXX only

HEXX and HBXX only

HEWZXX only

HEXX and HBXX only

HEWZXX only

HEXX and HBXX only

HEWZXX only

HEXX and HBXX only

HEWZXX only

HEXX and HBXX only

HEWZXX only

HEXX and HBXX only

HEWZXX only

HEXX and HBXX only

HEWZXX only

HEXX and HBXX only

HEWZXX only

HEXX and HBXX only

HEWZXX only

HEXX and HBXX only

HEWZXX only

HEXX and HBXX only

HEWZXX only

HEXX and HBXX only

HEWZXX only

HEXX and HBXX only

HEWZXX only

HEXX and HBXX only

HEWZXX only

HEXX and HBXX only

HEWZXX only

HEXX and HBXX only

HEWZXX only

HEXX and HBXX only

HEWZXX only

HEXX and HBXX only

HEWZXX only

HEXX and HBXX only

HEWZXX only

HEXX and HBXX only

HEWZXX only

HEXX and HBXX only

HEWZXX only

HEXX and HBXX only

HEWZXX only

HEXX and HBXX only

HEWZXX only

HEXX and HBXX only

HEWZXX only

HEXX and HBXX only

HEWZXX only

HEXX and HBXX only

HEWZXX only

HEXX and HBXX only

HEWZXX only

HEXX and HBXX only

HEWZXX only

HEXX and HBXX only

HEWZXX only

HEXX and HBXX only

HEWZXX only

HEXX and HBXX only

HEWZXX only

HEXX and HBXX only

HEWZXX only

HEXX and HBXX only

HEWZXX only

HEXX and HBXX only

HEWZXX only

HEXX and HBXX only

HEWZXX only

HEXX and HBXX only

HEWZXX only

HEXX and HBXX only

HEWZXX only

HEXX and HBXX only

HEWZXX only

HEXX and HBXX only

HEWZXX only

HEXX and HBXX only

HEWZXX only

HEXX and HBXX only

HEWZXX only

HEXX and HBXX only

HEWZXX only

HEXX and HBXX only

HEWZXX only

HEXX and HBXX only

HEWZXX only

HEXX and HBXX only

HEWZXX only

HEXX and HBXX only

HEWZXX only

HEXX and HBXX only

HEWZXX only

HEXX and HBXX only

HEWZXX only

HEXX and HBXX only

HEWZXX only

HEXX and HBXX only

HEWZXX only

HEXX and HBXX only

HEWZXX only

HEXX and HBXX only

HEWZXX only

HEXX and HBXX only

HEWZXX only

HEXX and HBXX only

HEWZXX only

HEXX and HBXX only

HEWZXX only

HEXX and HBXX only

HEWZXX only

HEXX and HBXX only



• This diagram is viewed from the foil side.

-To RDS Assy CN801

To AF Assy 15

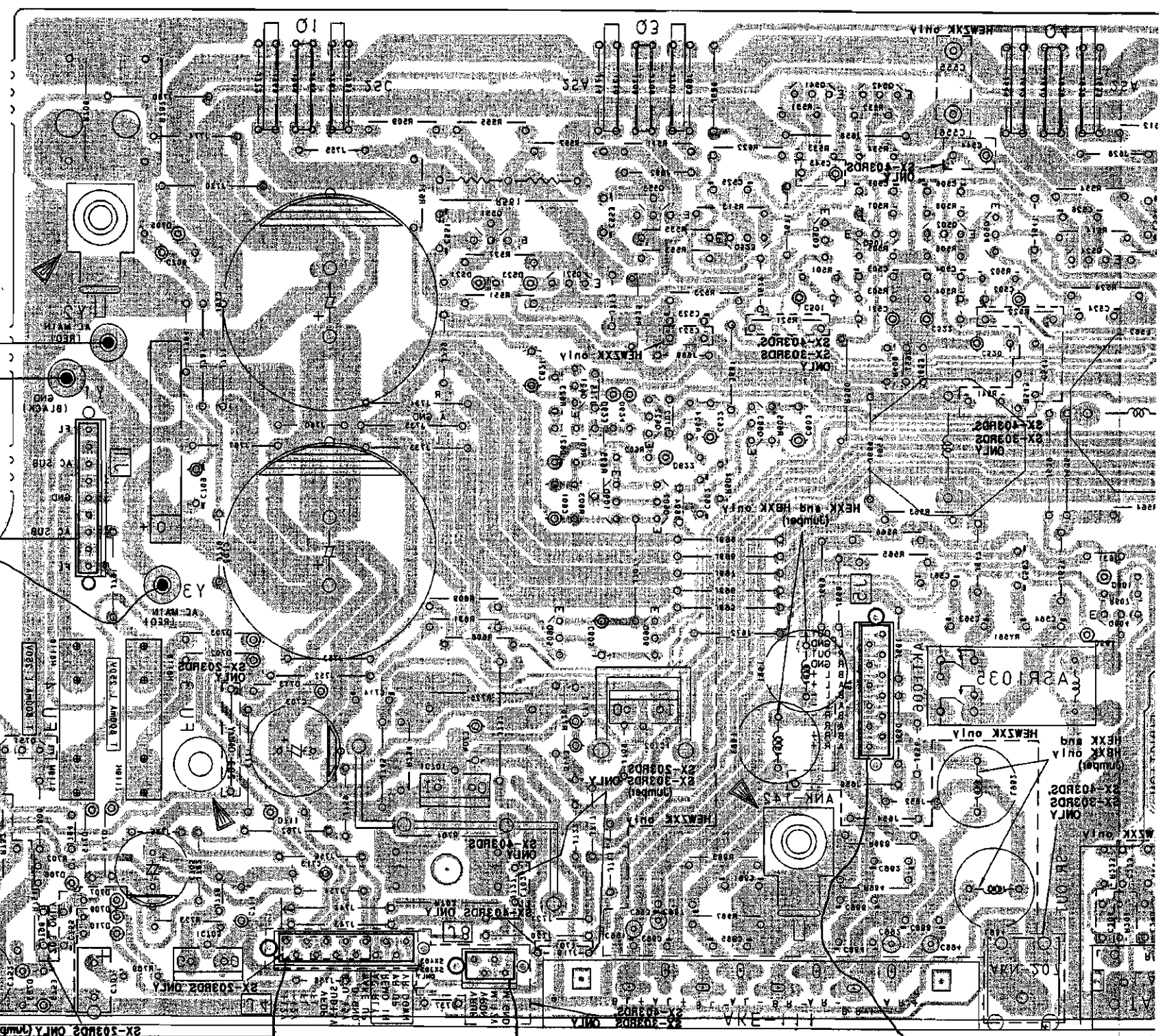

To SP SW Assy 12  
To VR Assy 18  
To FRONT Assy 14

To POWER TRANSFORMER T1

To POWER TRANSFORMER T1

SP SW ASSY

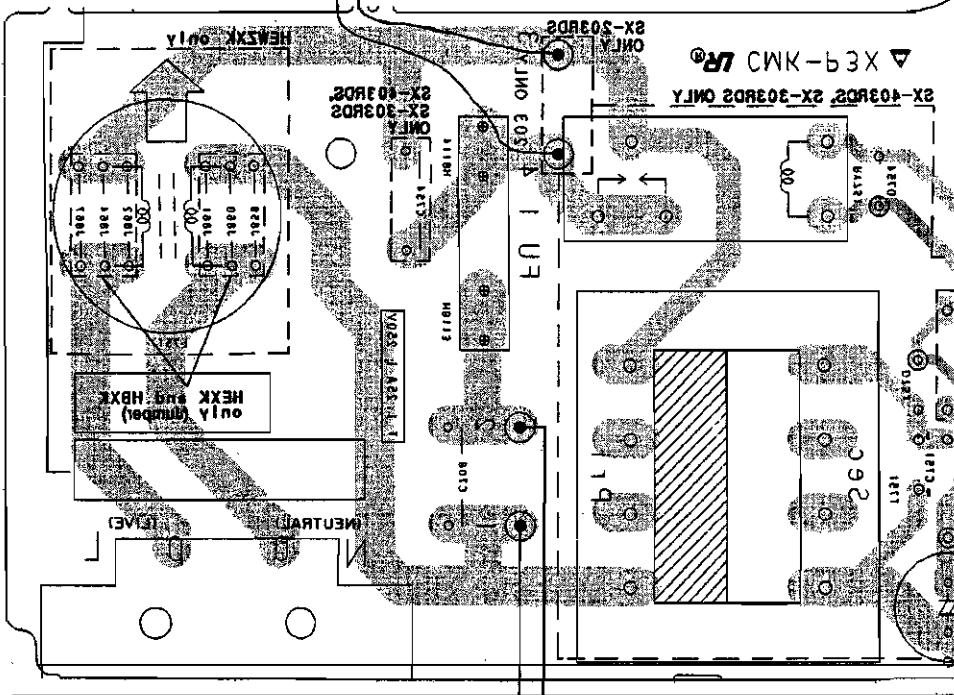
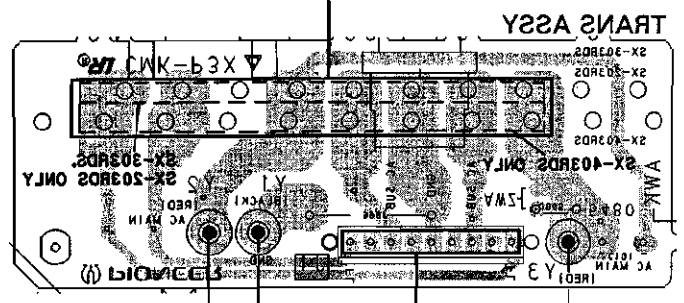
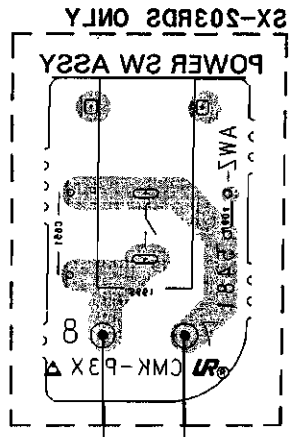

A

B

C

D

8

8

7

e

2

4

9

8

7

9

2

4

• This diagram is viewed from the mounted parts side.

FM/AM TUNER MODULE

A

A

Q6101

B

B

Q6215

Q6204

Q6102 Q6214

Q6104

Q6103  
Q6105

C

C

IC6202

VR6201

IC6201

Q6217

Q6202

Q6201 Q6203  
Q6218

VR6202

To AF assy

D

D

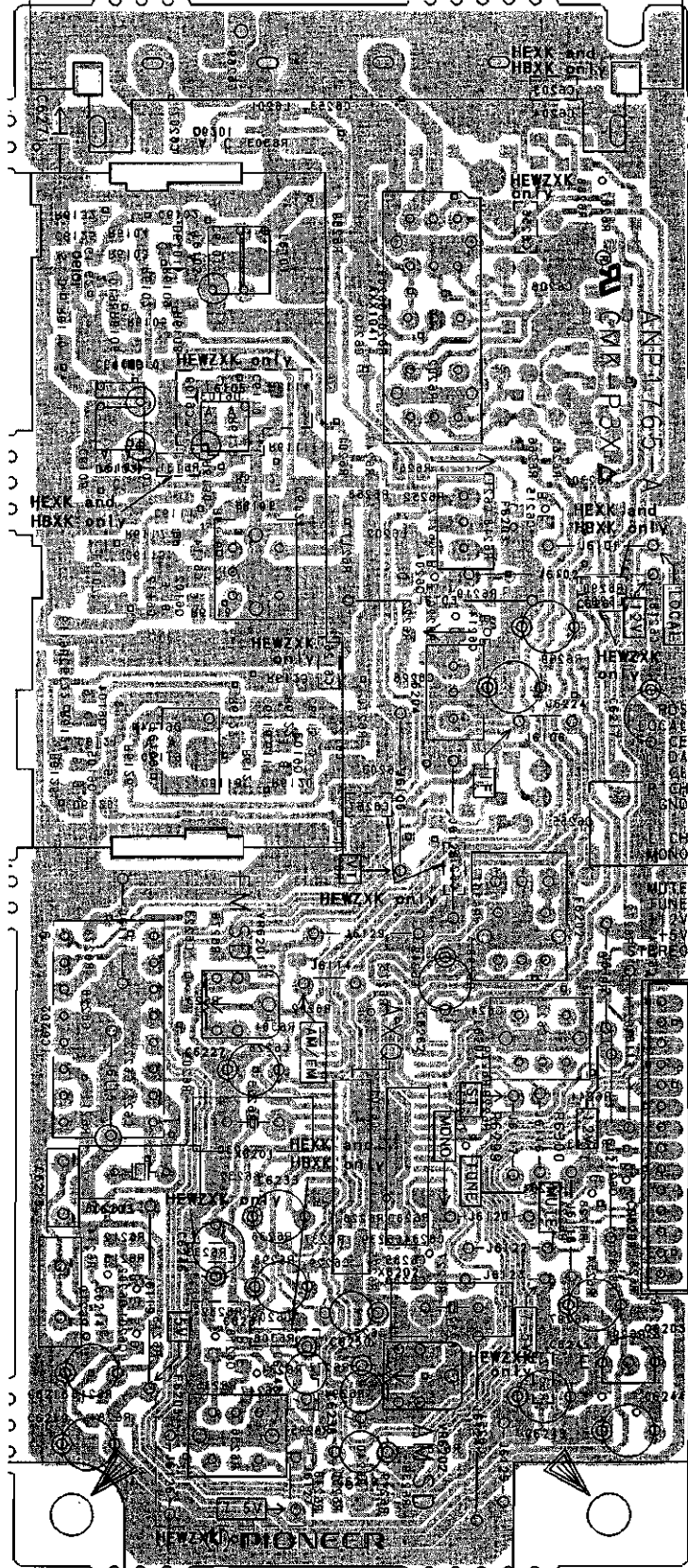



● This diagram is viewed from the foil side.

A

B

C

D

To AF assy

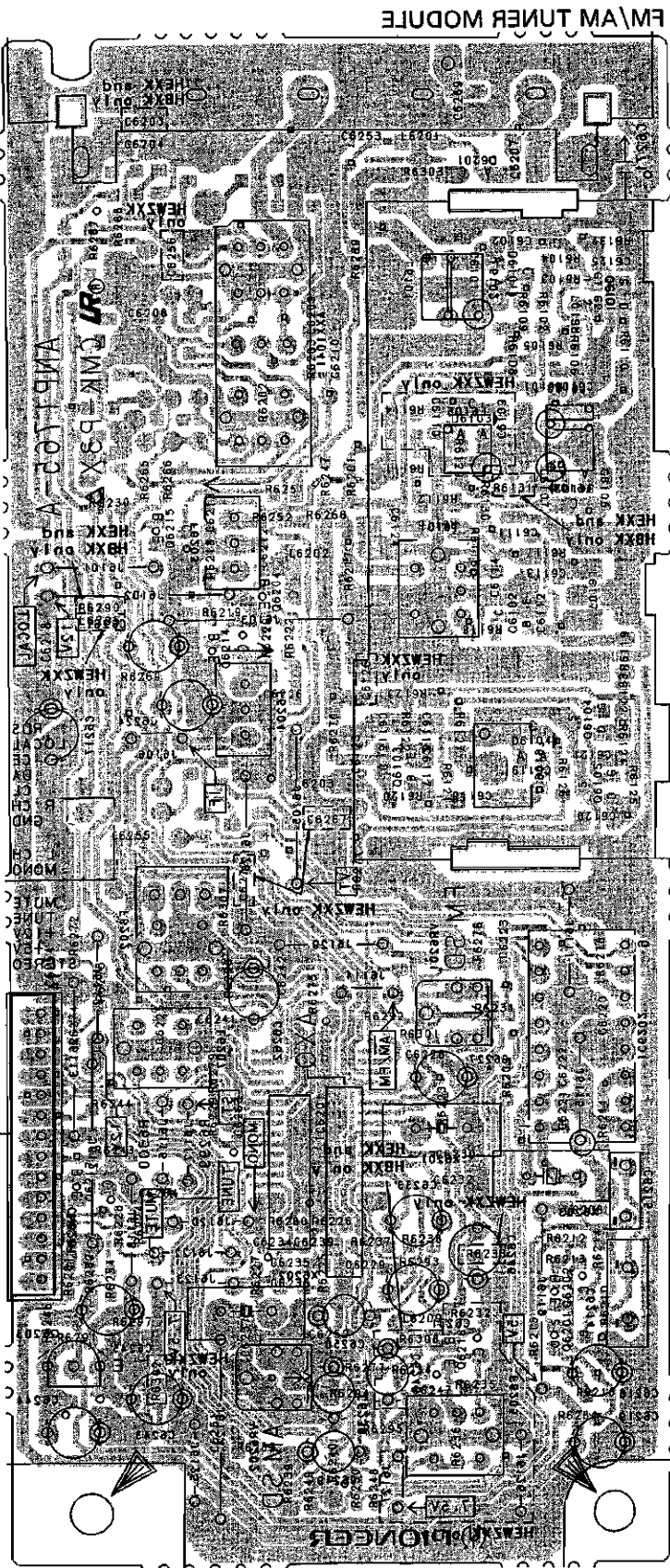

AP8501

AP8505

08101

08512

08504

08105 08514

08104

08103

08102

IC8505

IC8501

08517

08520

08501 08503

08518

A

B

C

D

3.3 AF ASSY, SP SW ASSY, POWER SW ASSY AND TRANS ASSY

This diagram is viewed from the mounted parts side.

A

B

C

D

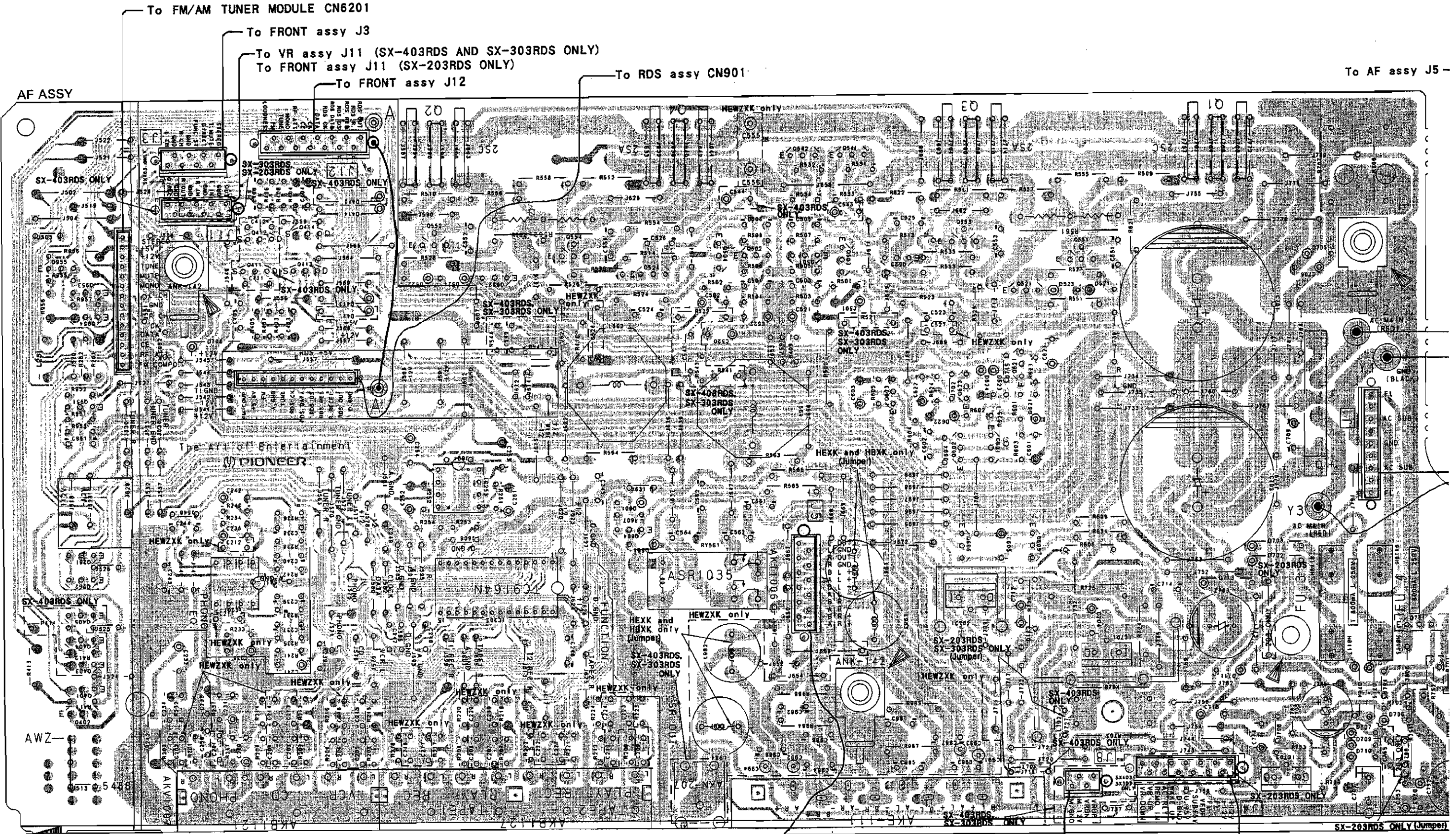

AF ASSY

To FM/AM TUNER MODULE CN6201

To FRONT assy J3

To VR assy J11 (SX-403RDS AND SX-303RDS ONLY)

To FRONT assy J11 (SX-203RDS ONLY)

To FRONT assy J12

To RDS assy CN901

To AF assy J5-

The Art of Entertainment  
PIONEER

Q955 Q953 Q954      Q411 Q412      Q413 Q414      Q522      Q522      Q544      Q524      Q504 Q502      Q542 Q501 Q541 Q503      Q523      Q553      Q521      Q551      IC701      IC703      Q751  
 Q951 Q261 Q262      IC201      IC253      IC202      Q604      Q603      Q502 Q522 Q601 Q621      Q605      Q605

To SP SW assy J5

To VR assy J8

To FRONT assy J4



This diagram is viewed from the foil side.

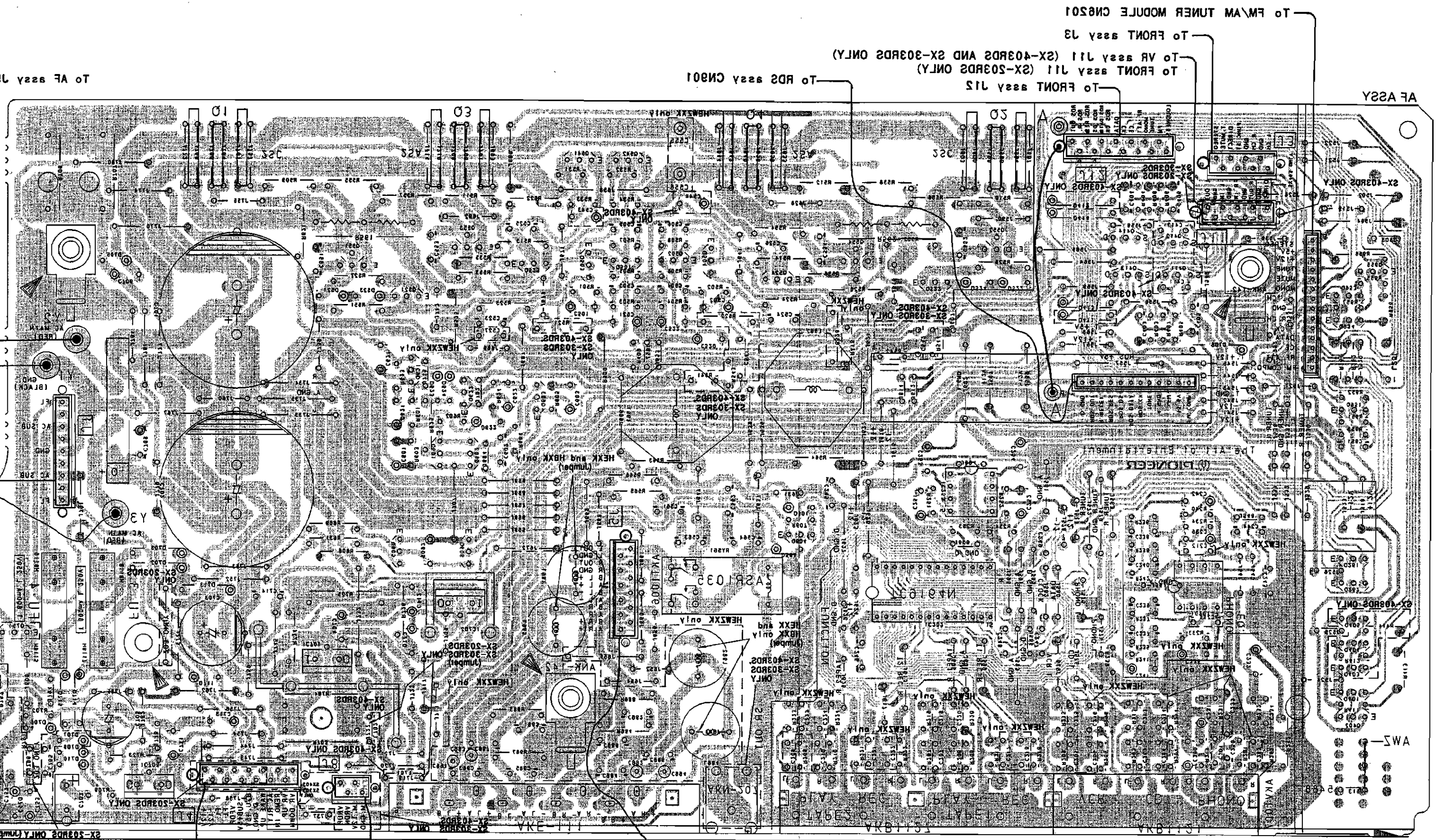

A

B

C

D

To AF assy J1

To FM/TUNER MODULE CN8201

To FRONT assy J3

To VR assy J11 (SX-403RDS AND SX-303RDS ONLY)

To FRONT assy J12

To RDS assy CN801

AF ASSY

SX-403RDS ONLY

SX-403RDS ONLY

SX-303RDS ONLY

SX-403RDS ONLY

SX-303RDS ONLY

SX-403RDS ONLY

SX-303RDS ONLY

SX-403RDS ONLY

SX-303RDS ONLY

SX-403RDS ONLY

SX-303RDS ONLY

SX-403RDS ONLY

SX-303RDS ONLY

SX-403RDS ONLY

SX-303RDS ONLY

SX-403RDS ONLY

SX-303RDS ONLY

SX-403RDS ONLY

SX-303RDS ONLY

SX-403RDS ONLY

SX-303RDS ONLY

SX-403RDS ONLY

SX-303RDS ONLY

SX-403RDS ONLY

SX-303RDS ONLY

SX-403RDS ONLY

SX-303RDS ONLY

SX-403RDS ONLY

SX-303RDS ONLY

SX-403RDS ONLY

SX-303RDS ONLY

SX-403RDS ONLY

SX-303RDS ONLY

SX-403RDS ONLY

SX-303RDS ONLY

SX-403RDS ONLY

SX-303RDS ONLY

SX-403RDS ONLY

SX-303RDS ONLY

SX-403RDS ONLY

IC203

IC201

IC205

IC206

IC207

IC208

IC209

IC210

IC211

IC203

IC201

IC205

IC206

IC207

IC208

IC209

IC210

IC211

IC203

IC201

IC205

IC206

IC207

IC208

IC209

IC210

IC211

IC203

IC201

IC205

IC206

IC207

IC208

IC209

IC210

IC211

IC203

IC201

IC205

IC206

IC207

IC208

IC209

IC210

IC211

IC203

IC201

IC205

IC206

IC207

IC208

IC209

IC210

IC211

IC203

IC201

IC205

IC206

IC207

IC208

IC209

IC210

IC211

IC203

IC201

IC205

IC206

IC207

IC208

IC209

IC210

IC211

IC203

IC201

IC205

IC206

IC207

IC208

IC209

IC210

IC211

IC203

IC201

IC205

IC206

IC207

IC208

IC209

IC210

IC211

IC203

IC201

IC205

IC206

IC207

IC208

IC209

IC210

IC211

IC203

IC201

IC205

IC206

IC207

IC208

IC209

IC210

IC211

IC203

IC201

IC205

IC206

IC207

IC208

IC209

IC210

IC211

IC203

IC201

IC205

IC206

IC207

IC208

IC209

IC210

IC211

IC203

IC201

IC205

IC206

IC207

IC208

IC209

IC210

IC211

IC203

IC201

IC205

IC206

IC207

IC208

IC209

IC210

IC211

IC203

IC201

IC205

IC206

IC207

IC208

IC209

IC210

IC211

IC203

IC201

IC205

IC206

IC207

IC208

IC209

IC210

IC211

To VR assy J8

To SP SW assy J2

To FRONT assy J4









TYPES	SX-203RDS			SX-303RDS			SX-403RDS		
ASSY NO	HEXK	HBXK	HEWZKX	HEXK	HBXK	HEWZKX	HEXK	HBXK	HEWZKX
AF Assy	AWZ5476	AWZ5622	AWZ5482	AWZ5484	AWZ5623	AWZ5487	AWZ5488	AWZ5489	AWZ5491

\* MARKS indicate differences between models

MODELS	SX-203RDS			SX-303RDS			SX-403RDS		
TYPES	HEXK	HBXK	HEWZKX	HEXK	HBXK	HEWZKX	HEXK	HBXK	HEWZKX
R	521,522	1.2K	1.2K	1K	1K	910	910	910	910
	543,544			1K		910			910
706	2.2K 2W	2.2K 2W	2.7K 2W	2.7K 2W	2.7K 2W	2.7K 2W	2.7K 2W	2.7K 2W	2.7K 2W
707	2.2K 2W	2.2K 2W	2.7K 2W	2.7K 2W	2.7K 2W	2.7K 2W	2.7K 2W	2.7K 2W	2.7K 2W
C	701, 702	ACH1244 (5600/50)	ACH1244 (5600/50)	ACH1105 (6800/50)	ACH1105 (6800/50)	ACH1245 (6200/50)	ACH1245 (6200/50)	ACH1245 (6200/50)	ACH1245 (6200/50)
	985, 986	0.01	0.01	0.01	0.01	0.01	0.01	0.01	0.01
D	521,522	47/16	47/16	100/16	100/16	100/16	100/16	100/16	100/16
	701	D358A20	D358A20	D358A20	D358A20	D358A20F	D358A20F	D358A20F	D358A20F
RY	561	ASR1035	ASR1035	ASR1035	ASR1035	ASR112	ASR112	ASR112	ASR112
IC	201, 253	NJM4558DP	NJM4558DP	NJM4558DP	NJM4558DP	UPC4570C	UPC4570C	UPC4570C	UPC4570C
FU	1	AEK-509 (11.5A/250V)	AEK-509 (11.5A/250V)	AEK-510 (11.6A/250V)	AEK-510 (11.6A/250V)	AEK-511 (12A/250V)	AEK-511 (12A/250V)	AEK-511 (12A/250V)	AEK-511 (12A/250V)

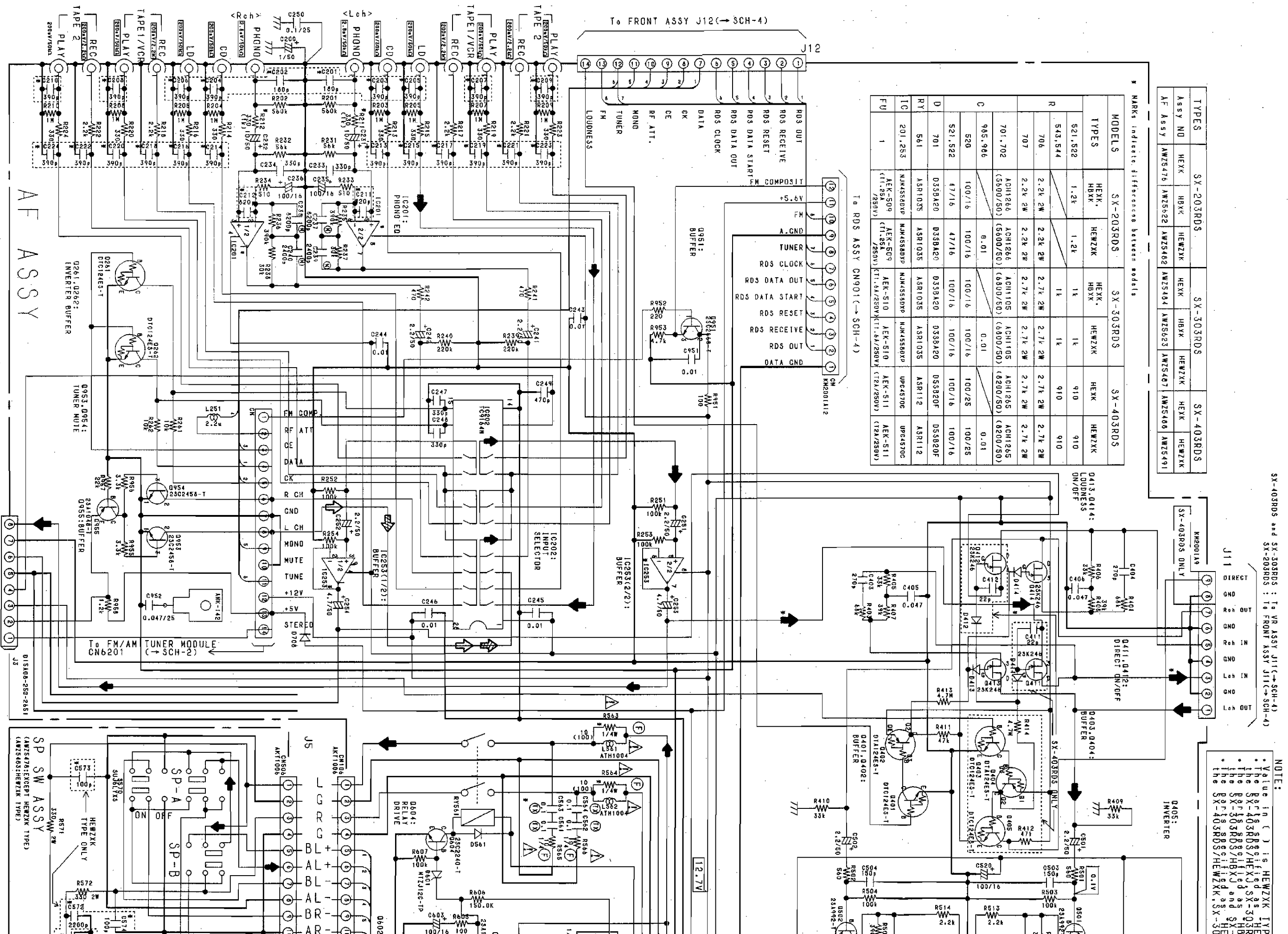

SX-403RDS and SX-303RDS : To VR ASSY J11(→SCH-4)  
 SX-203RDS : To FRONT ASSY J11(→SCH-4)

J11 DIRECT GND Rch OUT GND Rch IN GND Lch IN GND Lch OUT

J12 TO FRONT ASSY J12(→SCH-4)  
 1 RDS OUT  
 2 RDS RECEIVE  
 3 RDS RESET  
 4 RDS DATA START  
 5 RDS DATA OUT  
 6 RDS CLOCK  
 7 DATA  
 8 OK  
 9 CE  
 10 RF ATT.  
 11 MONO  
 12 TUNER  
 13 FM  
 14 LOUDNESS

J3 L OUT GND R OUT GND FUNC ST DIRECT TUNER MUTE STEREO

J5 TO FM/AM TUNER MODULE (→SCH-2)  
 1 GND 2 GND 3 GND 4 GND 5 GND 6 GND 7 GND 8 GND 9 GND 10 GND 11 GND 12 GND 13 GND 14 GND 15 GND 16 GND 17 GND 18 GND 19 GND 20 GND 21 GND 22 GND 23 GND 24 GND 25 GND 26 GND 27 GND 28 GND 29 GND 30 GND 31 GND 32 GND 33 GND 34 GND 35 GND 36 GND 37 GND 38 GND 39 GND 40 GND 41 GND 42 GND 43 GND 44 GND 45 GND 46 GND 47 GND 48 GND 49 GND 50 GND 51 GND 52 GND 53 GND 54 GND 55 GND 56 GND 57 GND 58 GND 59 GND 60 GND 61 GND 62 GND 63 GND 64 GND 65 GND 66 GND 67 GND 68 GND 69 GND 70 GND 71 GND 72 GND 73 GND 74 GND 75 GND 76 GND 77 GND 78 GND 79 GND 80 GND 81 GND 82 GND 83 GND 84 GND 85 GND 86 GND 87 GND 88 GND 89 GND 90 GND 91 GND 92 GND 93 GND 94 GND 95 GND 96 GND 97 GND 98 GND 99 GND 100 GND

NOTE:  
 Value in ( ) is HEWZKX TYPE  
 • The Rch Lch RDS/HEWZKX and SX-303RDS/HEWZKX are the same as the Rch Lch RDS/HEWZKX and SX-203RDS/HEWZKX.  
 • The Rch Lch RDS/HEWZKX and SX-303RDS/HEWZKX are the same as the Rch Lch RDS/HEWZKX and SX-203RDS/HEWZKX.  
 • The Rch Lch RDS/HEWZKX and SX-303RDS/HEWZKX are the same as the Rch Lch RDS/HEWZKX and SX-203RDS/HEWZKX.

SCH-3

AF ASSY, SP SW ASSY,  
 POWER SW ASSY, TRANS ASSY.

C201-C224:HEWZKX TYPE ONLY

AF ASSY

NOTE:

Value in ( ) is HEWZK TYPE.  
 The parts specified as SX-403RDS/HEWZK are required for the SX-403RDS/HEWZK and SX-203RDS/HEWZK.  
 The parts specified as SX-303RDS/HEWZK are required for the SX-303RDS/HEWZK and SX-203RDS/HEWZK.  
 The parts specified as SX-203RDS/HEWZK are required for the SX-403RDS/HEWZK and SX-303RDS/HEWZK.

The parts specified as SX-403RDS are required for the SX-403RDS/HEWZK and SX-303RDS/HEWZK.  
 The parts specified as SX-303RDS/HEWZK are required for the SX-303RDS/HEWZK and SX-203RDS/HEWZK.  
 The parts specified as SX-203RDS/HEWZK are required for the SX-403RDS/HEWZK and SX-303RDS/HEWZK.

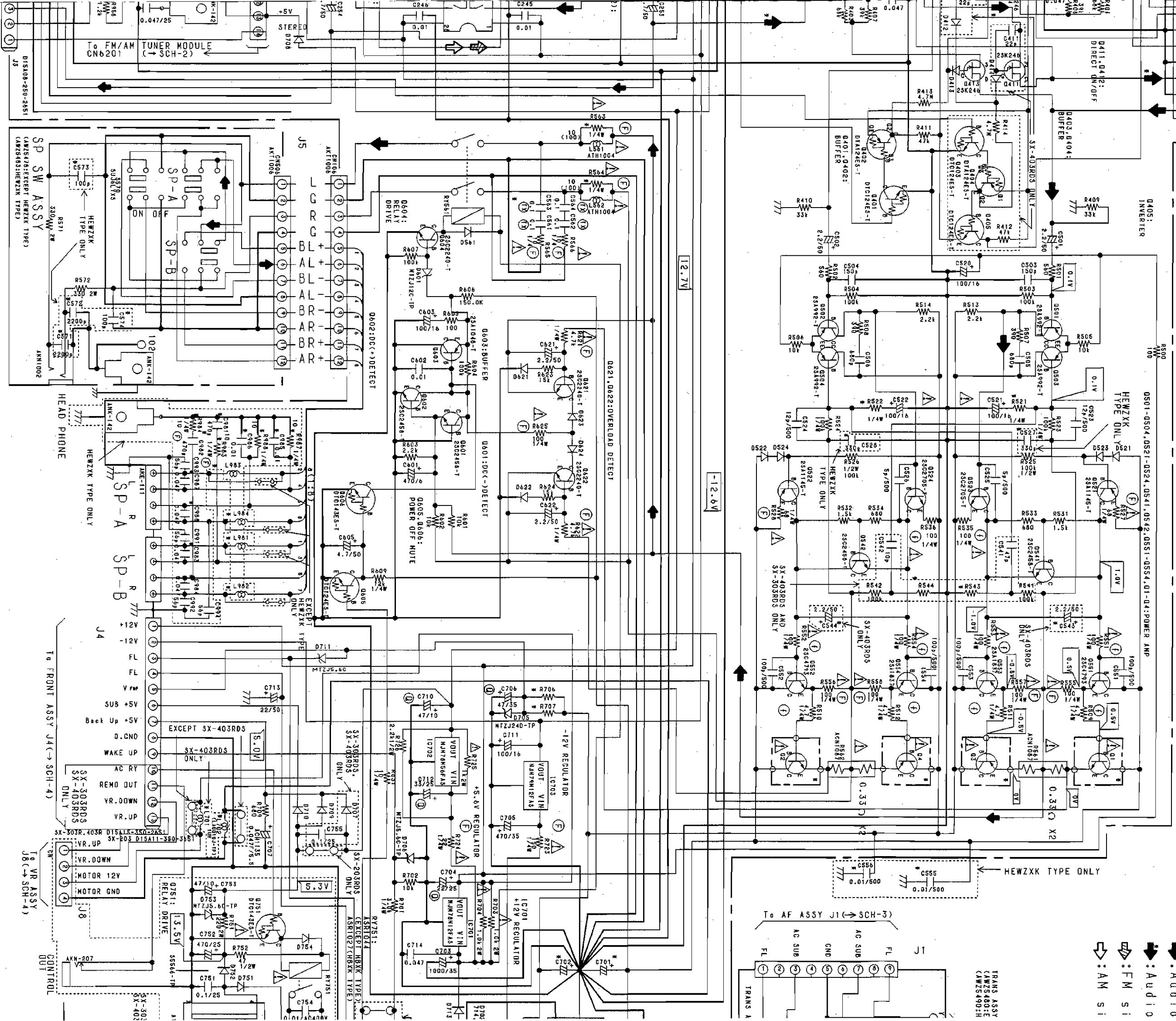

- ↓ : Audio
- ⇓ : Audio
- ⇓ : FM
- ⇓ : AM

TRANS ASSY  
 (AMZ9380-E  
 (AMZ8490-H

To AF ASSY J1 (SCH-3)

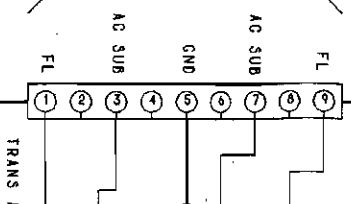

To FM/AM TUNER MODULE  
 CN6201 (SCH-2)

SP SW ASSY  
 (AMZ5478-EXCEPT HEWZK TYPE)  
 (AMZ8453-HEWZK TYPE)

HEAD PHONE

To FRONT ASSY J4 (SCH-4)

To FRONT ASSY J6 (SCH-4)

CONTROL

HEWZK TYPE are required for...  
The SX-403RDS/HBKX and SX-303RDS are required for...  
The SX-203RDS/HBKX and SX-203RDS/HBWZK are required for...

- ➔ Audio signal route
- ➔ Audio signal route (Direct)
- ➔ FM signal route
- ➔ AM signal route

SCH-3

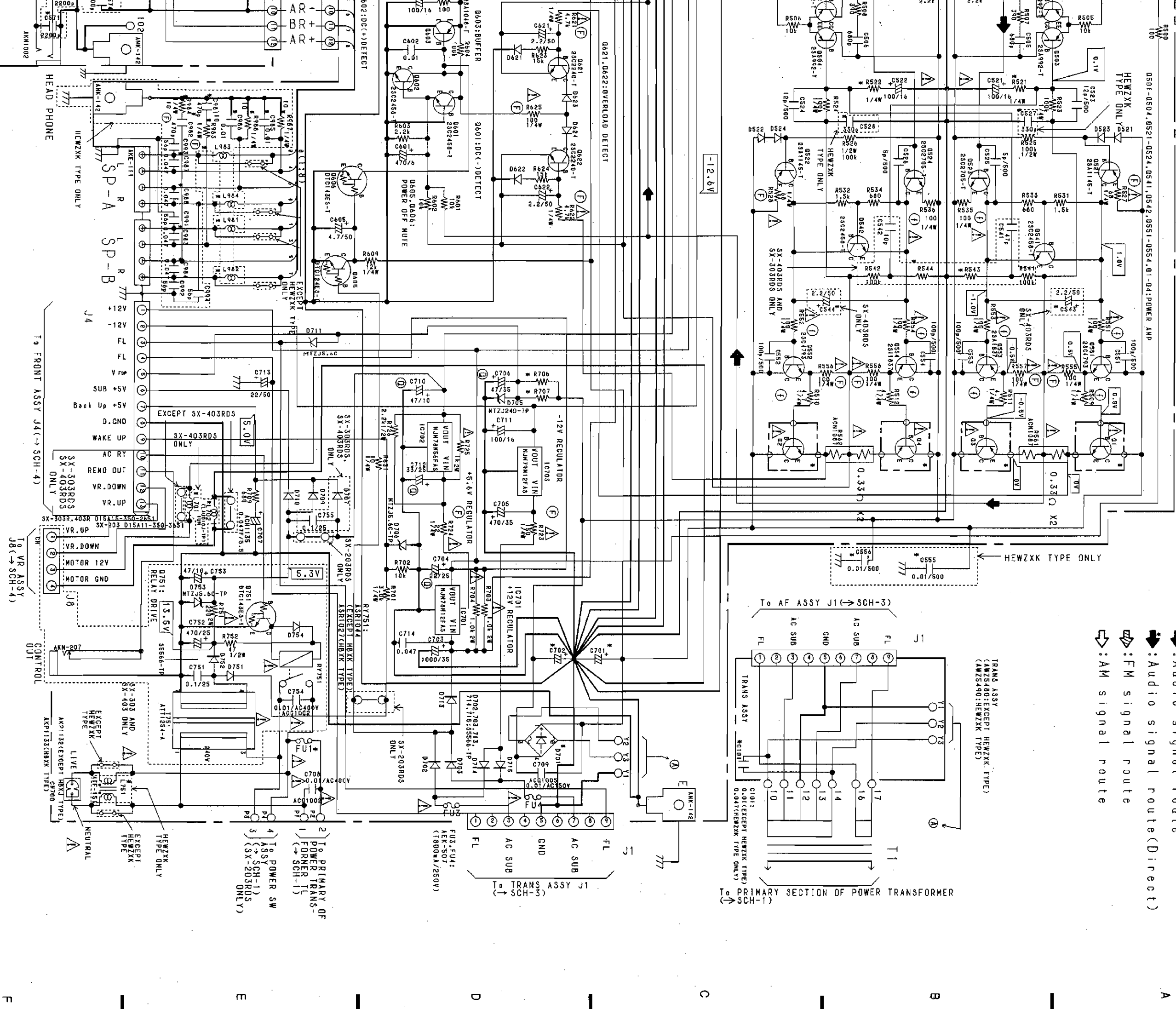
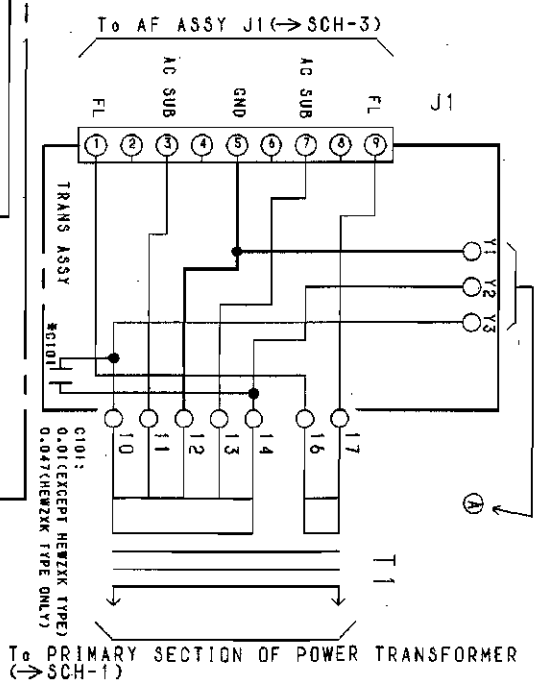

SCH-3

AF ASSY, SP SW ASSY, POWER SW ASSY, TRANS ASSY

3.4 FRONT ASSY, VR ASSY AND RDS ASSY

FRONT ASSY (AWZ5489: SX-403RDS)  
(AWZ5485: SX-303RDS)  
(AWZ5477: SX-203RDS)

NOTE:  
• The parts specified as "SX-403RDS" are required for the SX-403RDS/HEXK and HEWZK.  
• The parts specified as "SX-303RDS" are required for the SX-303RDS/HEXK, HBXK and HEWZK.  
• The parts specified as "SX-203RDS" are required for the SX-203RDS/HEXK, HBXK and HEWZK.

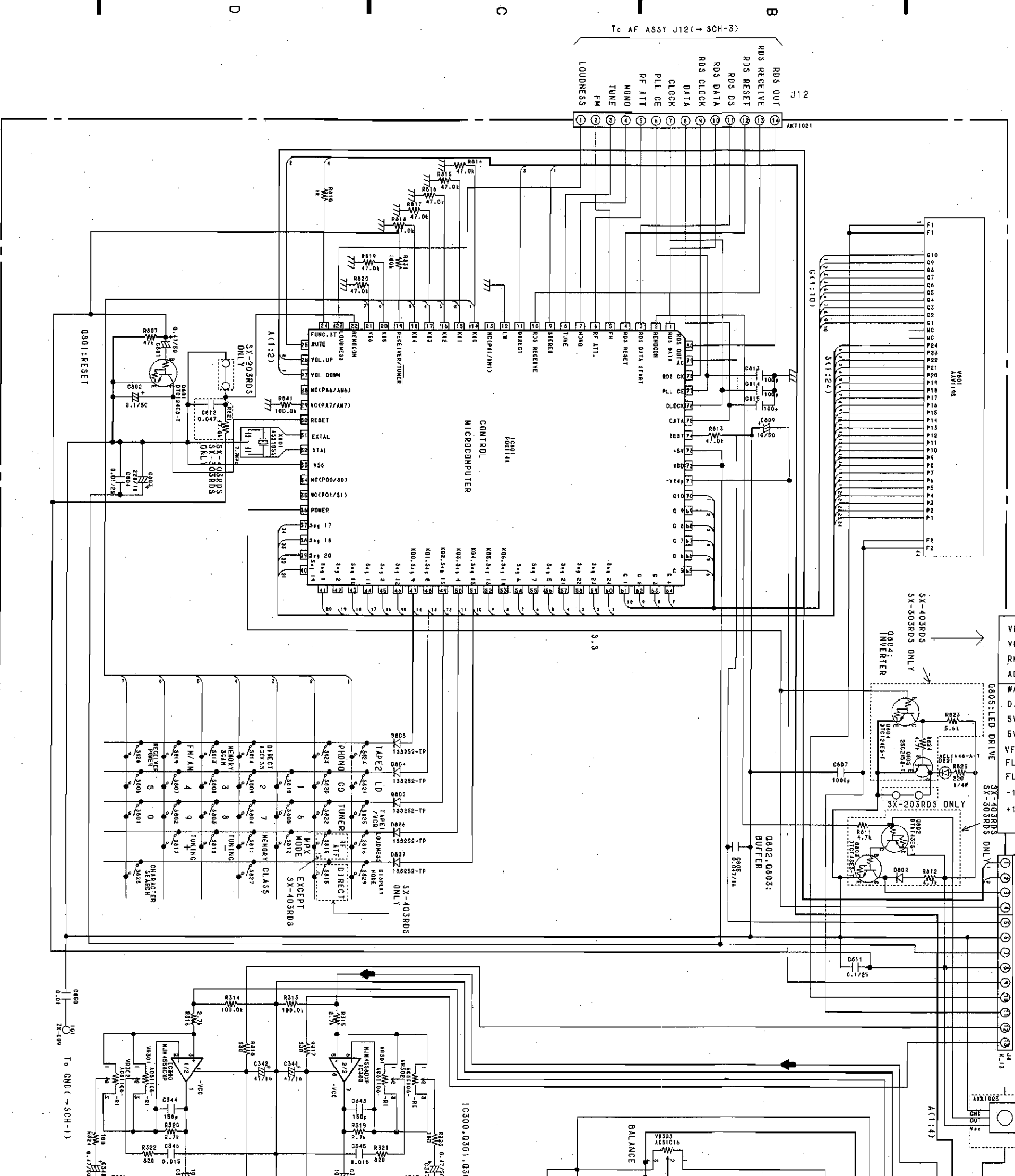

SCH-4

FRONT ASSY, VR ASSY, RDS ASSY

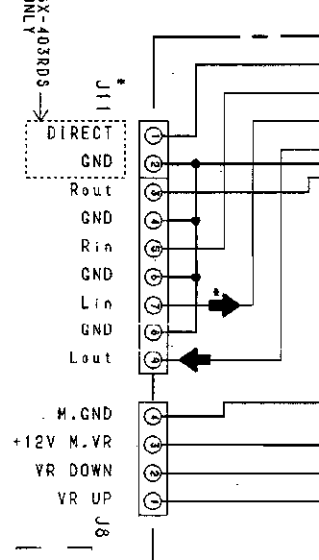
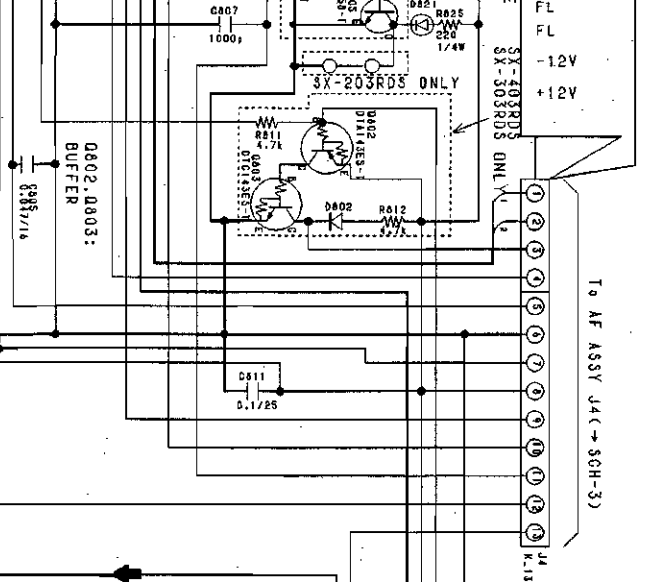
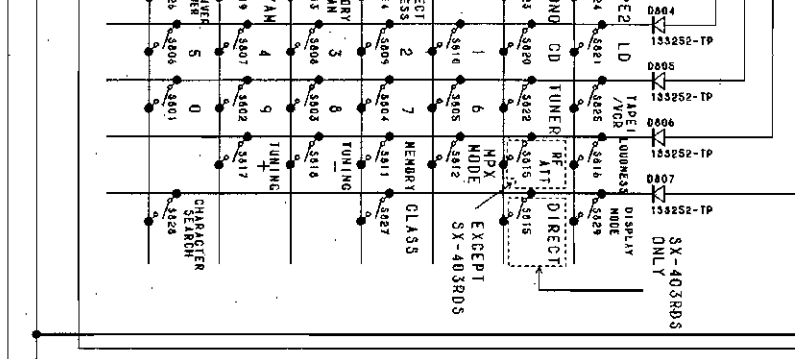
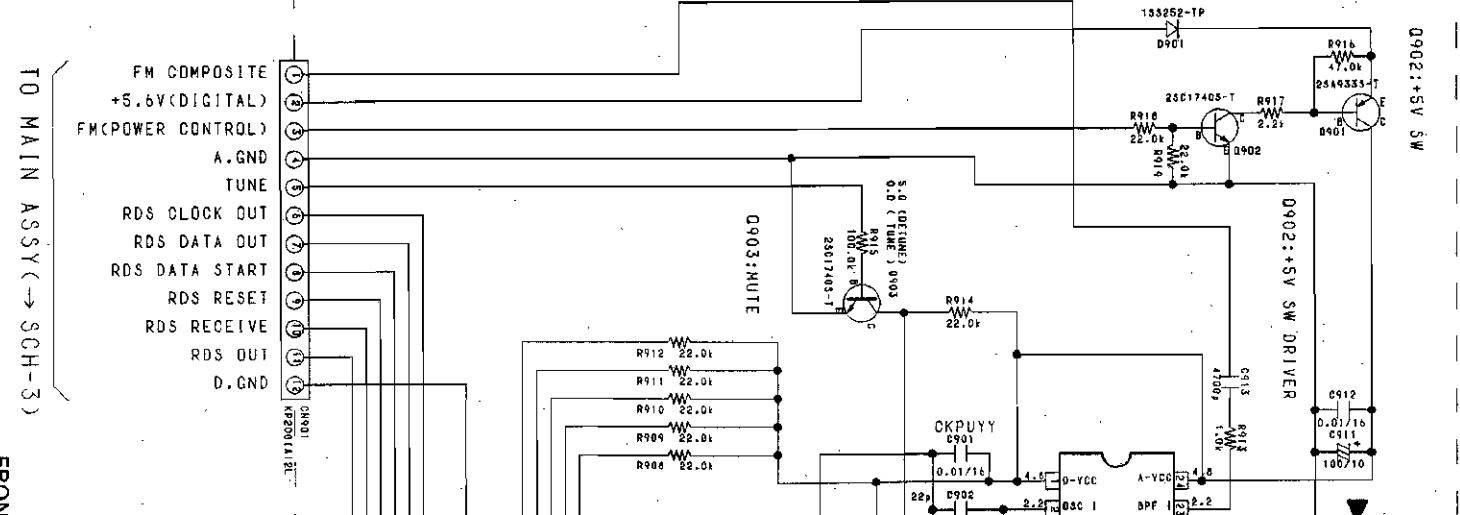
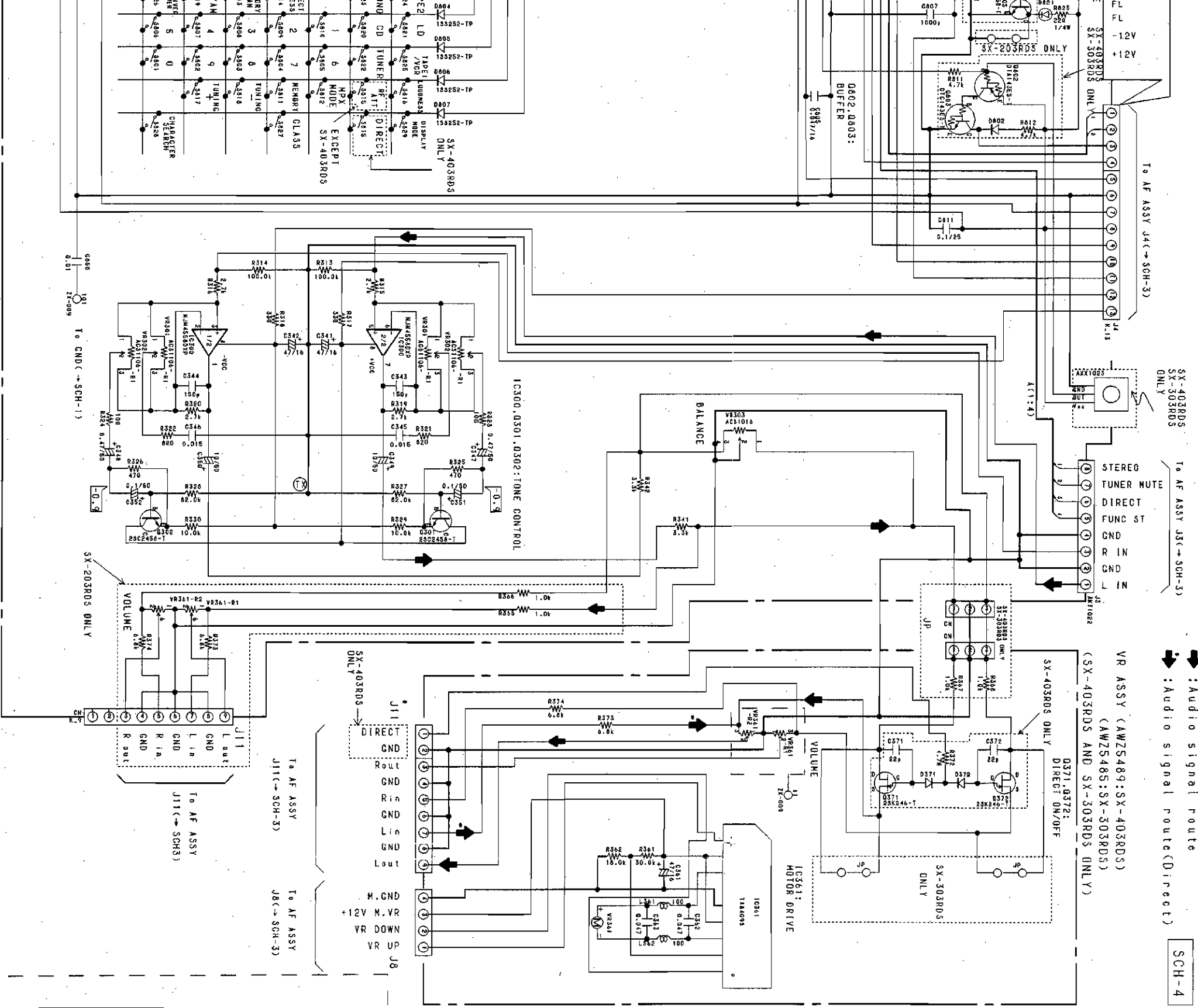



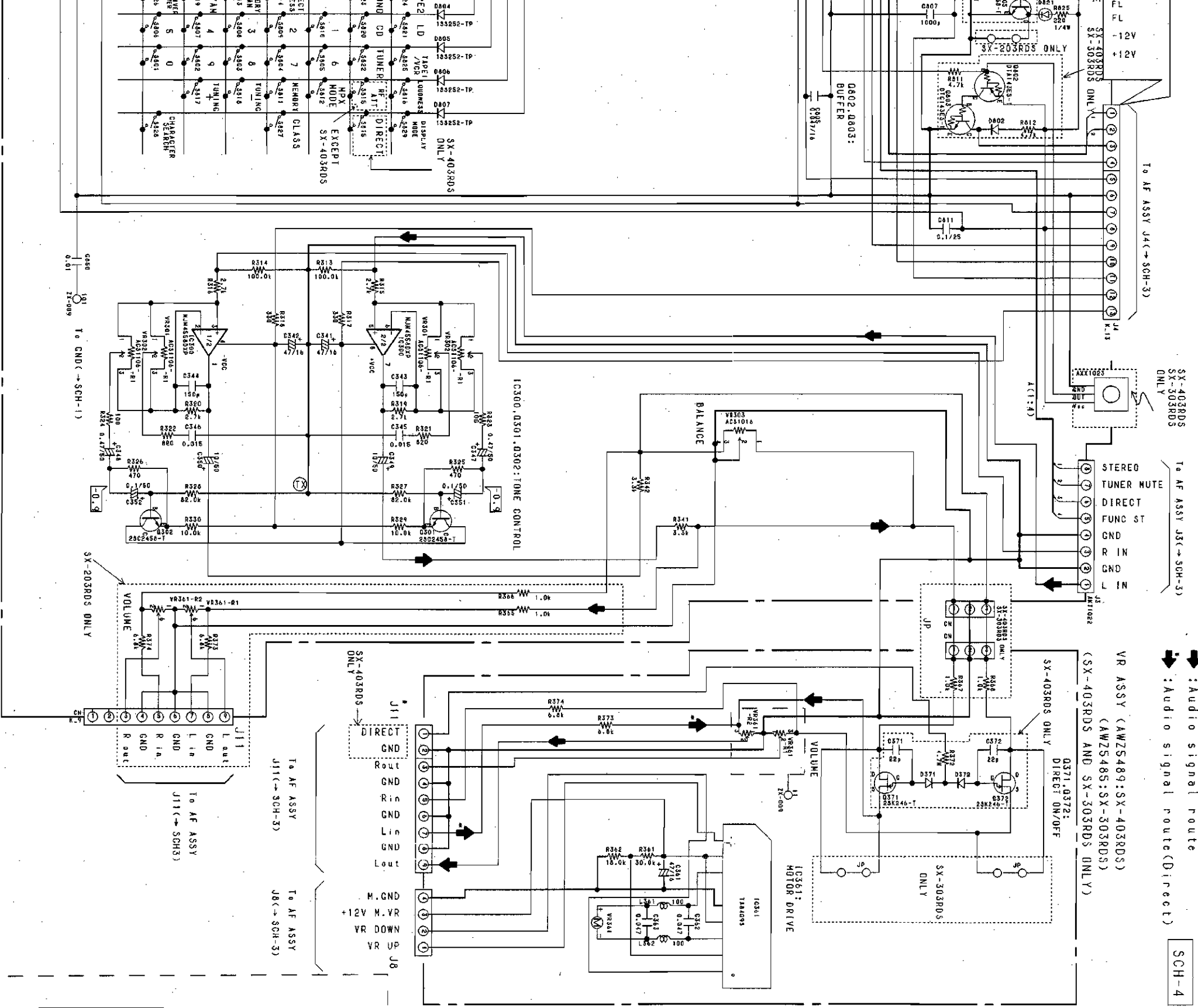

SCH-4

➔ : Audio signal route  
➔ : Audio signal route (Direct)

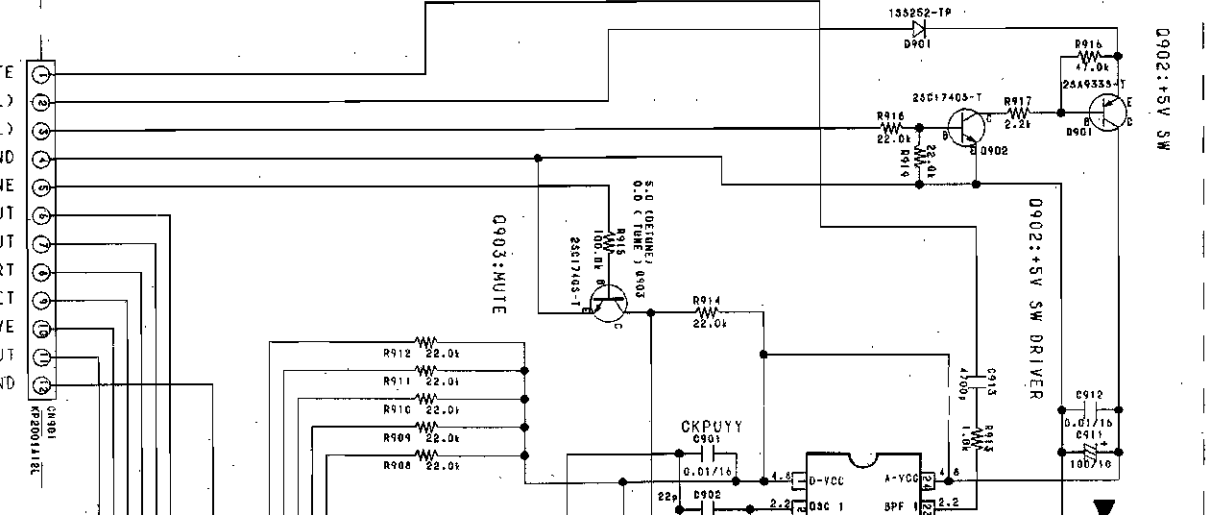
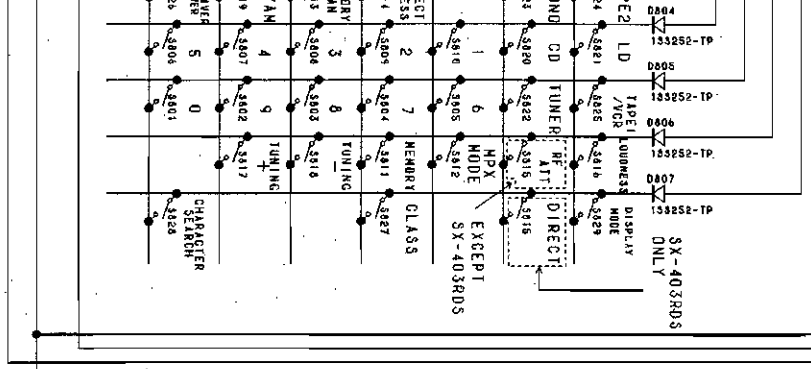

⇨ Audio signal route  
 ⇨ Audio signal route(Direct)

SCH-4

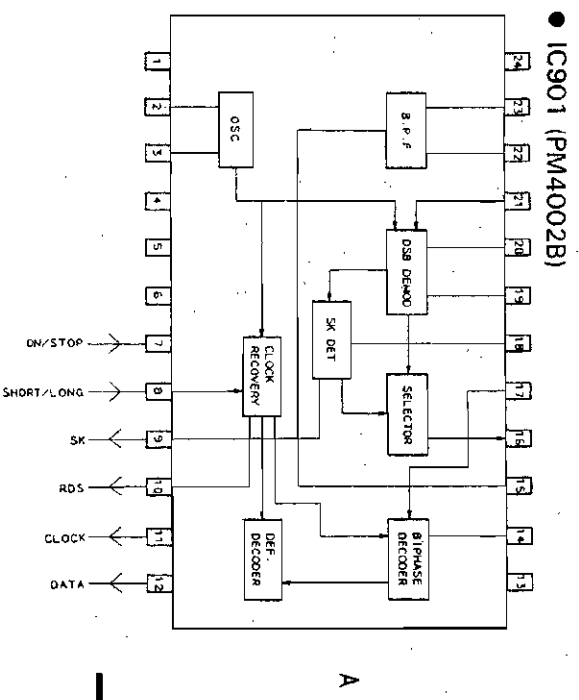
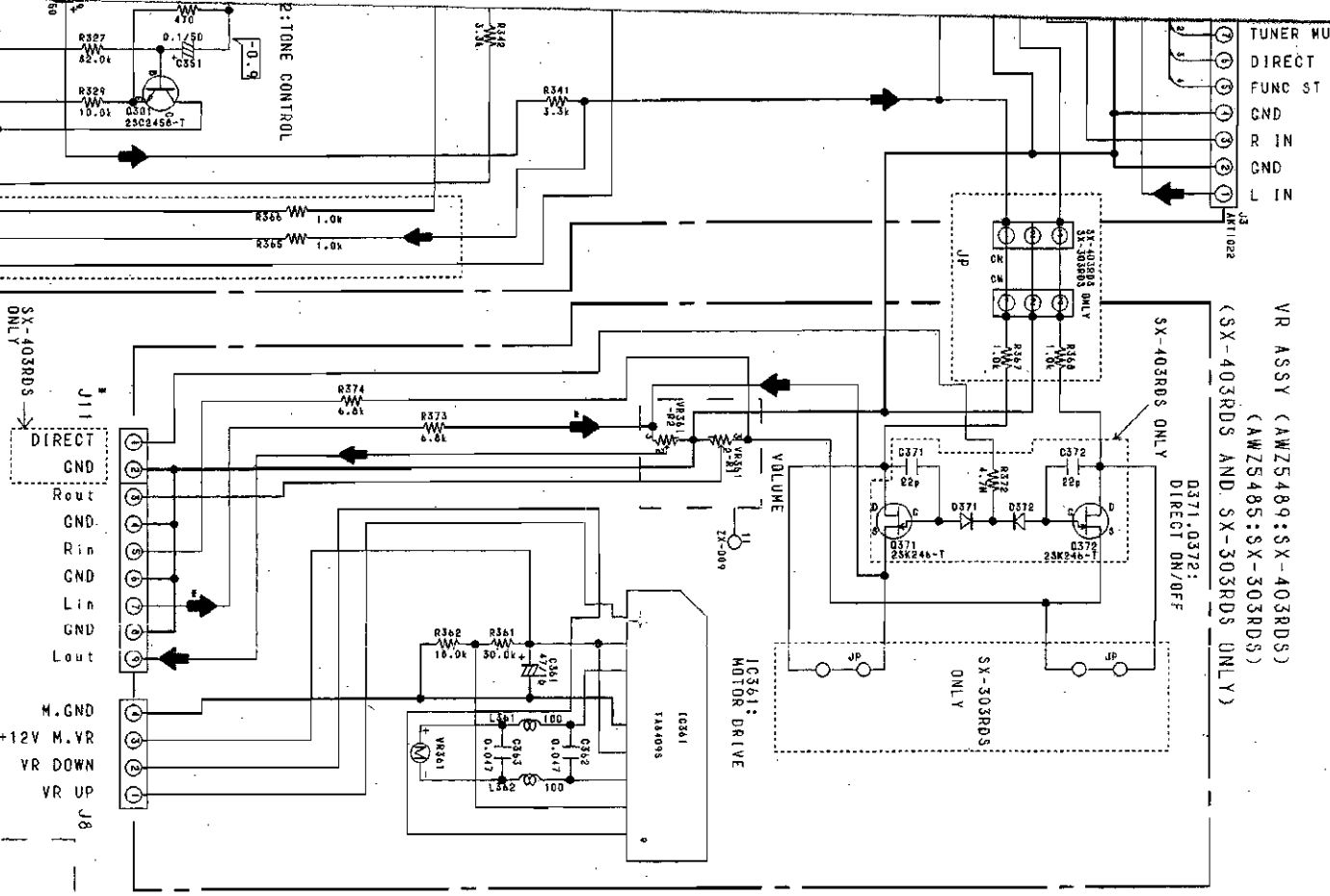

● IC901 (PM4002B)

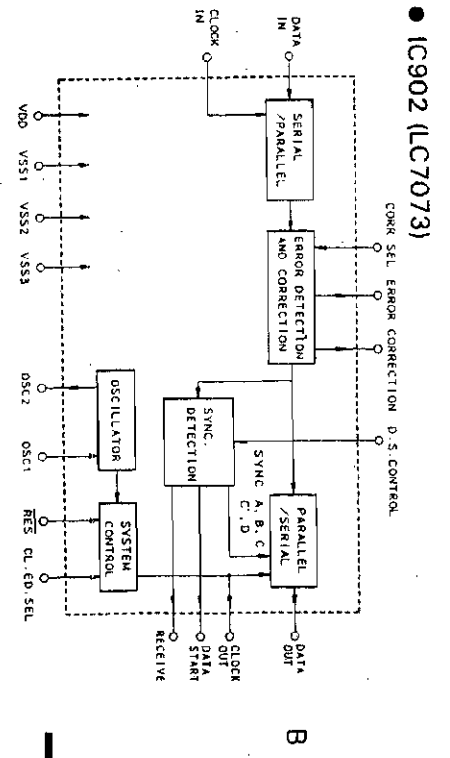

● IC902 (LC7073)

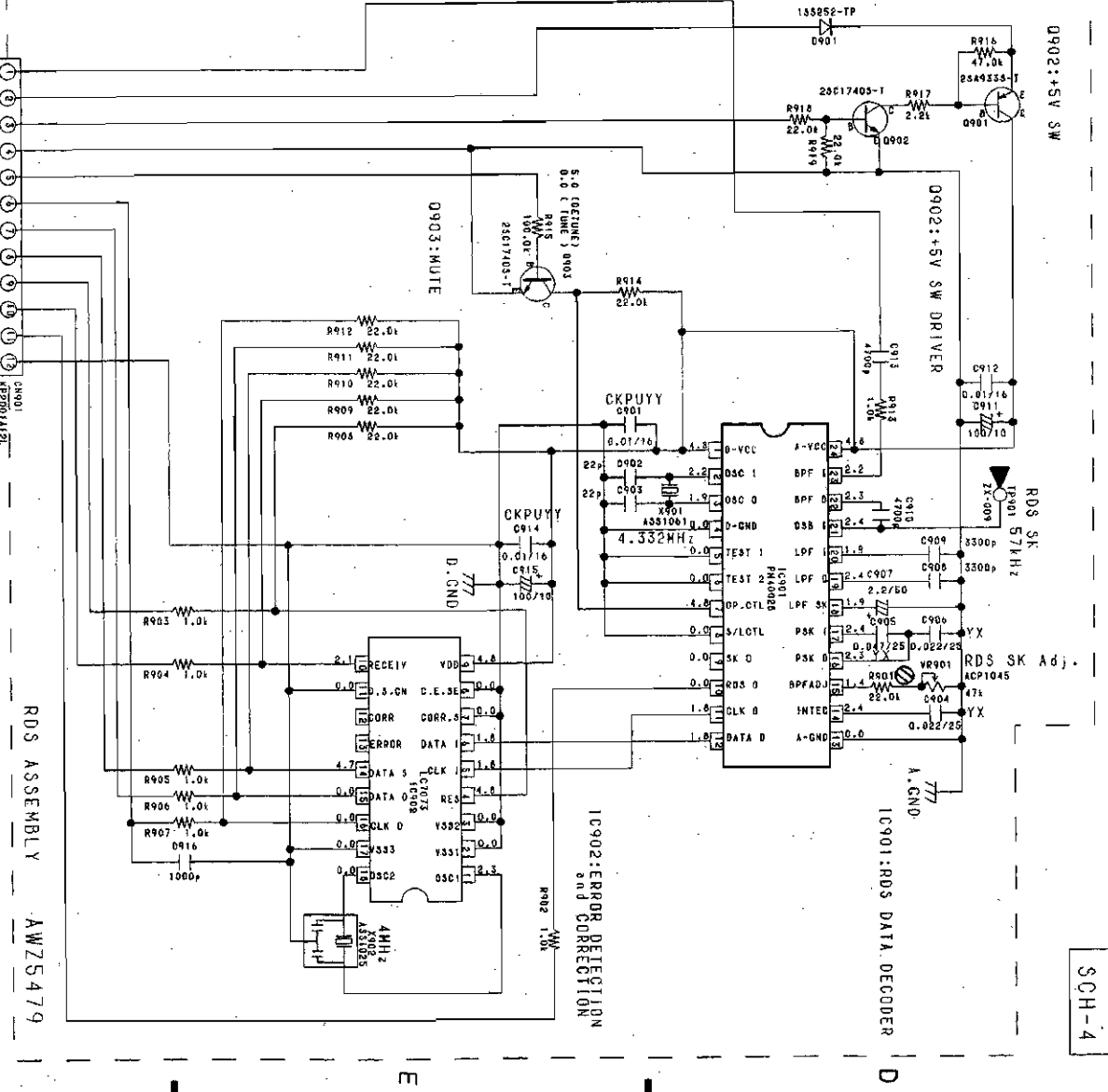

SCH-4

TO MAIN ASSY (→ SCH-3)  
 FM COMPOSITE  
 +5.6V(DIGITAL)  
 FM(POWER CONTROL)  
 A.GND  
 TUNE  
 RDS CLOCK OUT  
 RDS DATA OUT  
 RDS DATA START  
 RDS RESET  
 RDS RECEIVE  
 RDS OUT  
 D.GND

FRONT ASSY, VR ASSY, RDS ASSY

SCH-4

RDS ASSEMBLY AWZ5479

SX-403RDS AND SX-303RDS ONLY

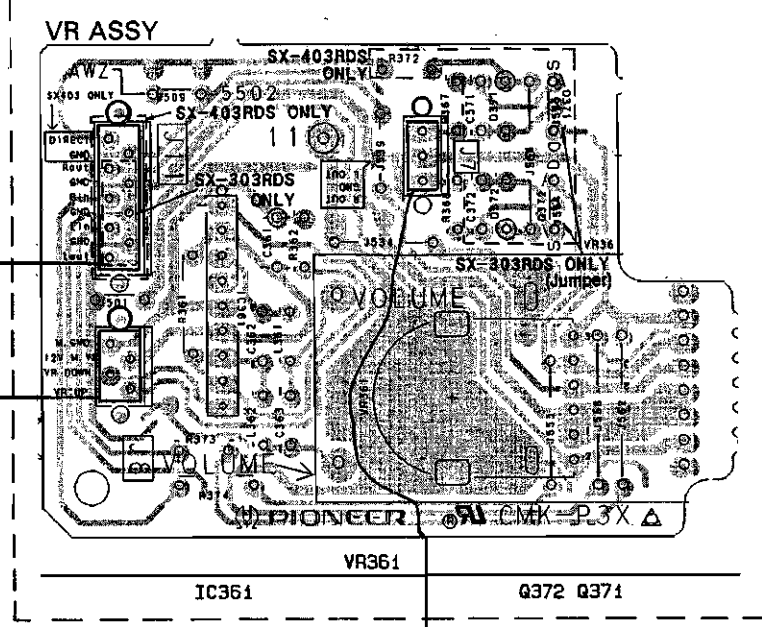

To AF assy J11

To AF assy J8

To AF assy J3

RDS ASSY

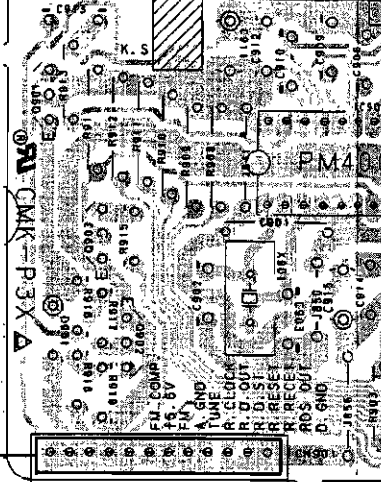

To AF assy

A

B

FRONT ASSY

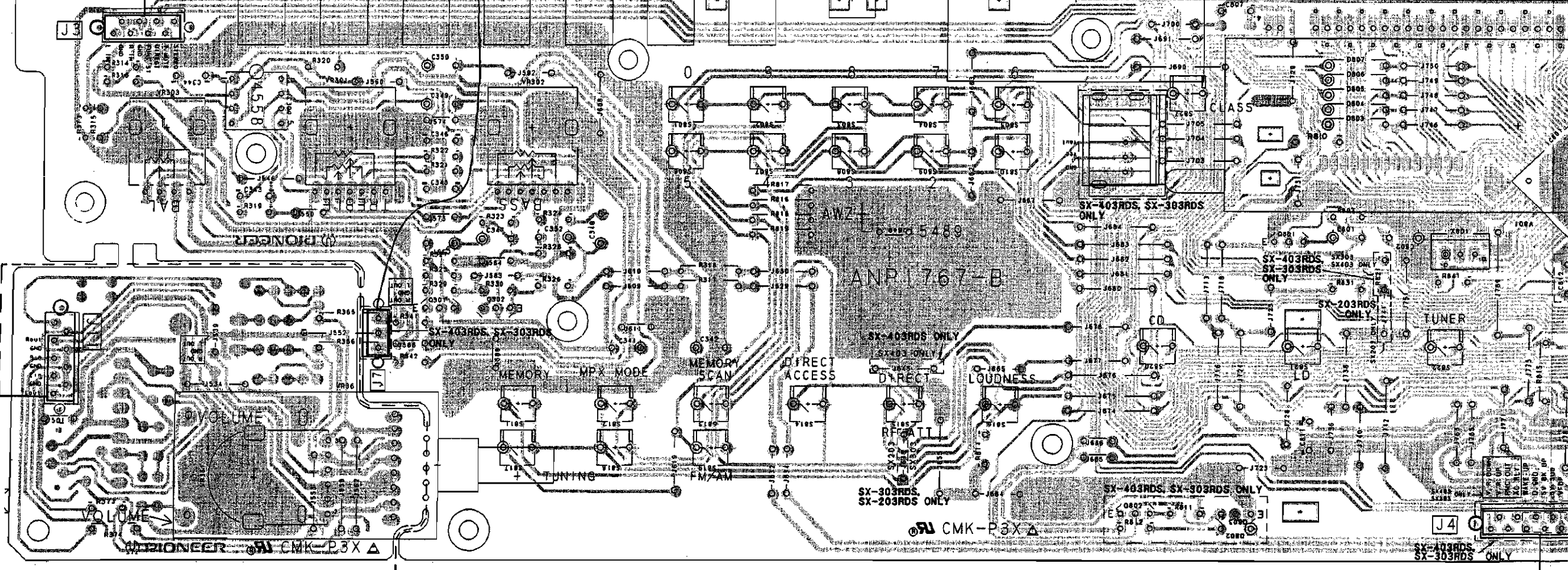

To AF assy J11

C

D

• This diagram is viewed from the mounted parts side.

3RDS ONLY

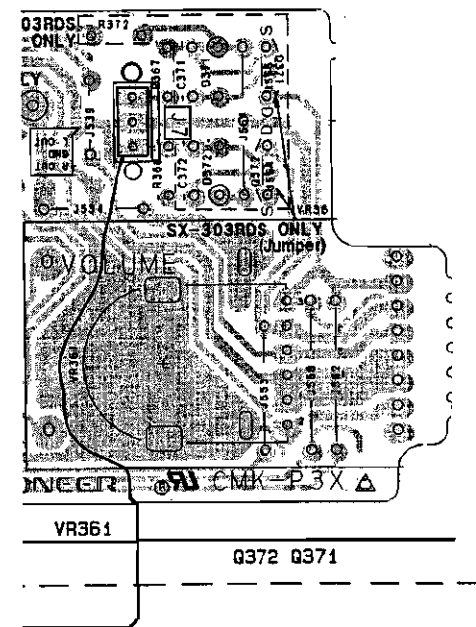

RDS ASSY

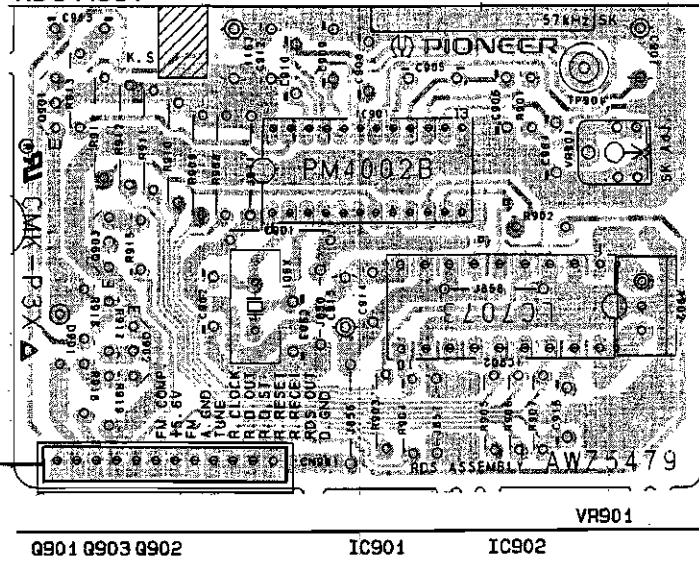

To AF assy

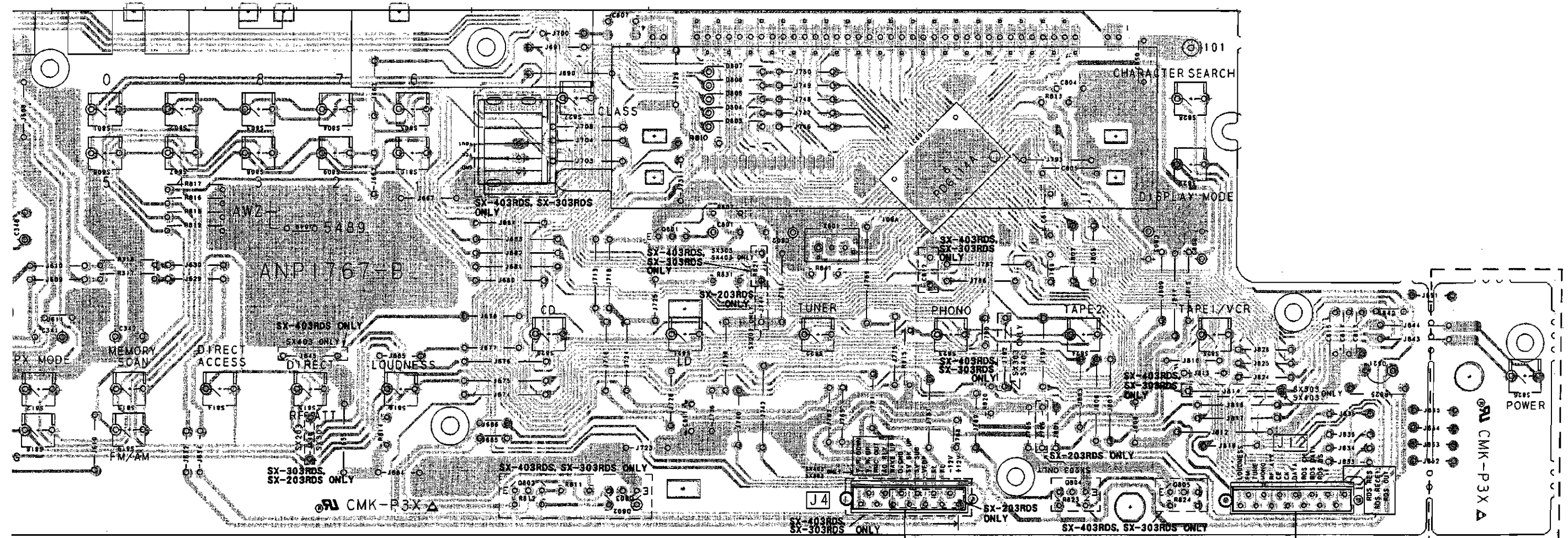

Q802 Q803 Q801 IC801 Q804 Q805

To AF assy J4

To AF assy J2

• This diagram is viewed from the mounted parts side.



SX-403RDS, SX-303RDS, SX-203RDS

ONLY

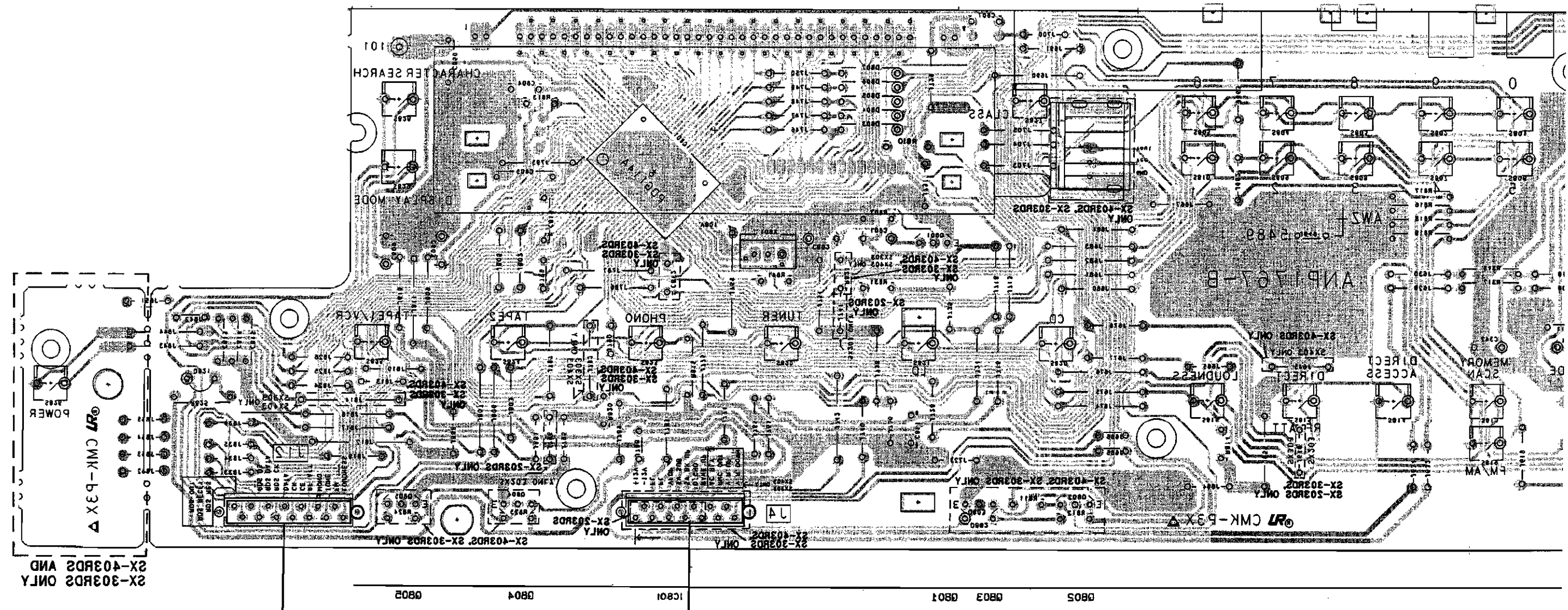
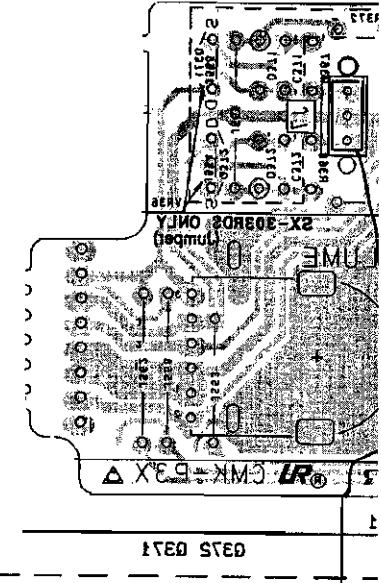
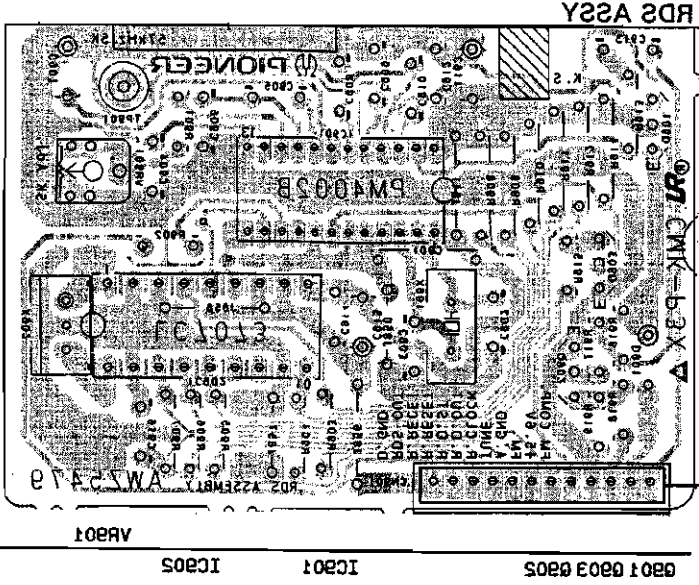

A

B

C

D

28

● This diagram is viewed from the foil side.





# SX-403RDS, SX-303RDS, SX-203RDS

Mark	No.	Description	Parts No.
	Q523, Q524		2SC2705
	Q551, Q552		2SC4793
	Q411, Q412 (SX-403RDS only)		2SK246
	Q413, Q414		2SK246
	Q402		DTA124ES
	Q404 (SX-403RDS only)		DTA124ES
	Q261, Q262, Q401		DTC124ES
	Q403, Q405 (SX-403RDS only)		DTC124ES
	Q605		DTC124ES
	Q606		DTC143ES
	Q751 (SX-403RDS and SX-303RDS only)		DTC143ES
	D411, D412 (SX-403RDS only)		1SS252
	D413, D414, D521-D524, D561		1SS252
	D621-D624, D708-D710		1SS252
	D707, D751, D754		1SS252
	(SX-403RDS and SX-303RDS only)		
	D701 (For SX-403RDS)		D5SB20F
	D701 (For SX-303RDS and SX-203RDS)		D3SBA20 (A)
	D601		MTZJ12C
	D705		MTZJ24D
	D711		MTZJ5.6C
	D706		MTZJ5.6C
	D753 (SX-403RDS and SX-303RDS only)		MTZJ5.6C
	D702, D703, D713-D715		S5566
	D752 (SX-403RDS and SX-303RDS only)		S5566
<b>COILS AND FILTERS</b>			
	L251		LAU2R2J
	L561, L562 (0.7uH)		ATH1004
	L701, L702 (SX-403RDS only)		LAU010J
<b>TRANSFORMERS</b>			
	T751 (SX-403RDS and SX-303RDS only)		ATT1254
<b>SWITCHES AND RELAYS</b>			
	RY561 (For SX-403RDS)		ASR-112
	RY561 (For SX-303RDS and SX-203RDS)		ASR1035
	RY751 (SX-403RDS and SX-303RDS only)		ASR1044
<b>CAPACITORS</b>			
△	C708 (0.01/AC400V)		ACG1002
△	C754 (0.01/AC400V)		ACG1002
	(SX-403RDS and SX-303RDS only)		
	C709 (0.01/AC150V)		ACG1005
	C707 (0.047F/5.5)		ACH1135
	C701, C702 (8200/50) (For SX-403RDS)		ACH1265
	C701, C702 (6800/50) (For SX-303RDS)		ACH1105
	C701, C702 (5600/50) (For SX-203RDS)		ACH1266
	C542 (SX-403RDS and SX-303RDS only)		CCCSL100C50
	C525, C526		CCCSL050C500
	C551-C554		CCCSL101K500
	C523, C524		CCCSL120K500
	C503, C504		CCCSL151J50
	C403, C404		CCCSL271J50
	C411, C412 (SX-403RDS only)		CCPUSL220J50
	C541 (SX-403RDS and SX-303RDS only)		CCPUSL470J50
	C200		CEAS010M50
	C231, C232		CEAS100M50
	C235, C236, C603, C711		CEAS101M16
	C703		CEAS102M35
	C713		CEAS220M50
	C241, C242, C251, C252		CEAS2R2M50
	C543, C544 (SX-403RDS only)		CEAS2R2M50
	C621, C622		CEAS2R2M50
	C753 (SX-403RDS and SX-303RDS only)		CEAS470M10

Mark	No.	Description	Parts No.
	C752 (SX-403RDS and SX-303RDS only)		CEAS471M25
	C705		CEAS471M35
	C601		CEAS471M6
	C253, C254, C605		CEAS4R7M50
	C521, C522 (For SX-403RDS)		CEEA101M16
	C521, C522 (For SX-303RDS)		CEAS101M16
	C521, C522 (For SX-203RDS)		CEAS470M16
	C501, C502 (For SX-403RDS)		CEEA2R2M50
	C501, C502 (For SX-303RDS and SX-203RDS)		CEAS2R2M50
	C704		CEHAQ220M25
	C712		CBHAQ930M25
	C710		CEHAQ470M10
	C706		CBHAQ470M35
	C520 (For SX-403RDS)		CEXA101M25
	C520 (For SX-303RDS and SX-203RDS)		CEAS101M16
	C561-C564		CFTXA104J50
	C405, C406		CFTXA473J50
	C243-C246, C602		CKCYF103Z50
	C714		CKCYF473Z50
	C751, C755 (For SX-403RDS and SX-303RDS only)		CKCYX104M25
	C505, C506		CKDYB681K50
	C951		CKDYF103Z50
	C250		CKDYX104M25
	C952		CKDYX473M25
	C233, C234, C247, C248		CKPUYB331K50
	C249		CKPUYB471K50
	C239, C240		CQMA242J50
	C237, C238		CQMA822J50
<b>RESISTORS</b>			
△	R561, R562 (0.33/5W)		ACN-139
	R525, R526		RD1/2PM104J
	R726		RD1/2PM222J
	R752 (SX-403RDS and SX-303RDS only)		RD1/2PM470J
	R631		RD1/4PM100J
	R523, R524		RD1/4PM104J
	R609		RD1/4PM123J
	R701		RD1/4PM302J
	R521, R522 (For SX-403RDS)		RD1/4PM911J
	R521, R522 (For SX-303RDS)		RD1/4PM102J
	R521, R522 (For SX-203RDS)		RD1/4PM122J
△	R563-R566		RD1/4PMF100J
△	R555-R558, R625		RD1/4PMF101J
△	R621, R622		RD1/4PMF472J
△	R527, R528		RD1/4PMF680J
△	R535, R536, R551-R554		RFA1/4PS101J
△	R723		RFA1/4PS151J
△	R724		RFA1/4PS220J
△	R509-R512		RFA1/4PS4R7J
△	R703, R704, R725		RS2LMP102J
△	R751 (SX-403RDS and SX-303RDS only)		RS2LMP221J
	R706, R707		RS2LMP272J
	(For SX-403RDS and SX-303RDS)		
	R706, R707 (For SX-203RDS)		RS2LMP222J
	R412 (SX-403RDS only)		RD1/8PM473J
	R414 (SX-403RDS only)		RD1/8PM475J
	R541, R542		RD1/8PM104J
	(SX-403RDS and SX-303RDS only)		
	R543, R544 (For SX-403RDS)		RD1/8PM911J
	R543, R544 (For SX-303RDS)		RD1/8PM102J
	Other Resistors		RD1/8PM□□□J

# SX-403RDS, SX-303RDS, SX-203RDS

Mark	No.	Description	Parts No.
<b>OTHERS</b>			
		PIN JACK 6P (PHONO, CD, VCR)	AKB1121
		PIN JACK 8P (TAPE1 PLAY/REC, TAPE2 PLAY/REC)	AKB1127
		SPEAKER TERMINAL 8-P JACK (CONTROL OUT) (SX-403RDS and SX-303RDS only)	AKB-111 AKN-207
CN700		AC INLET (1P)	AKP1132
		CABLE HOLDER (9P)	AKT1082
		HEAT SINK	ANH-575
		SCREW	BBZ30P080FMC
CN302		12P PLUG	KM2001A12

## FRONT ASSY

### SEMICONDUCTORS

IC300	NJM4558DXP
IC801	PDG114A
Q301, Q302	2SC2458
Q805 (SX-403RDS and SX-303RDS only)	2SC2458
Q802 (SX-403RDS and SX-303RDS only)	DTA143ES
Q801	DTC124ES
Q804 (SX-403RDS and SX-303RDS only)	DTC124ES
Q803 (SX-403RDS and SX-303RDS only)	DTC143ES
D802 (SX-403RDS and SX-303RDS only)	1SS252
D803-D807	1SS252
D821 (RED)	AEL1148

### SWITCHES AND RELAYS

S801-S825, S827-S829	ASG1029
S826 (SX-403RDS and SX-303RDS only)	ASG1029

### CAPACITORS

C343, C344	CCDSL151J50
C349, C350	CEAS100M50
C351, C352, C802	CEJA0R1M50
C809	CEJA100M50
C803	CEJA221M10
C341, C342	CEJA470M16
C347, C348, C801	CEJAR47M50
C345, C346	CFTXA153J50
C811	CKDYX104M25
C813-C815	CKPUYB101K50
C807	CKPUYB102K50
C804, C850	CKPUYF103Z25
C805, C816	CKPUYF473Z16
C812 (SX-403RDS and SX-303RDS only)	CKPUYF473Z16

### RESISTORS

VR303 (500k-B)	ACS1016
VR301, VR302 (30k-B5x2)	ACS1106
VR361 (SX-203RDS only)	ACT1071
R825	RD1/4PM221J
R365, R366 (SX-203RDS only)	RD1/8PM102J
R373, R374 (SX-203RDS only)	RD1/8PM682J
R811, R812, R824 (SX-403RDS and SX-303RDS only)	RD1/8PM472J
R821 (SX-403RDS and SX-303RDS only)	RD1/8PM473J
R823 (SX-403RDS and SX-303RDS only)	RD1/8PM562J
Other Resistors	RD1/8PM□□□□

Mark	No.	Description	Parts No.
<b>OTHERS</b>			
V801		FL TUBE CABLE HOLDER (3P) (For SX-403RDS and SX-303RDS)	AAV1195 AKT1076
X801		(7.70MHZ) REMOTE RECEIVER UNIT (SX-403RDS and SX-303RDS only)	ASS1055 AXX1023

## VR ASSY (SX-403RDS and SX-303RDS only)

### SEMICONDUCTORS

IC361	TA8409S
Q371, Q372 (SX-403RDS only)	2SK246
D371, D372 (SX-403RDS only)	1SS252

### COILS AND FILTERS

L361, L362	LAU101K
------------	---------

### CAPACITORS

C371, C372 (SX-403RDS only)	CCPUSL220J50
C361	CEAS470M16
C362, C363	CKPUYF473Z16

### RESISTORS

VR361 (100k-A5x2)	ACX1069
R372 (SX-403RDS only)	RD1/8PM475J
Other Resistors	RD1/8PM□□□□

### OTHERS

CABLE HOLDER (3P)	AKT1076
-------------------	---------

## POWER SW ASSY (SX-203RDS only)

### CAPACITORS

C651 (0.01/AC400V)	ACG1003
--------------------	---------

### SWITCHES AND RELAYS

S651	ASG1035
------	---------

## FM/AM TUNER MODULE

### SEMICONDUCTORS

IC6201	LA1836M
IC6202	LM7001J
Q6102	2SC2223
Q6203	2SC2235
Q6202	2SC2712
Q6103, Q6214	2SC2714
Q6201	2SK208
Q6104, Q6105	2SK302
Q6101	3SK194
Q6204	XDA124EK
Q6215, Q6217	XDC124EK
D6101, D6102, D6104	1SV228
D6201	HVU187

### COILS AND FILTERS

L6106	ATC1003
L6101	ATC1016
L6102	ATC1017
L6103	ATC1018
L6104	ATC1019

# SX-403RDS, SX-303RDS, SX-203RDS

Mark	No.	Description	Parts No.	Mark	No.	Description	Parts No.
	T6101		ATE-063		R6237		RS1/8S182J
	L6207 (F=10.7MHZ)		ATE1013		R6209		RS1/8S221J
	F6204		ATF-107		R6239		RS1/8S332J
	F6203		ATF-119		R6112		RS1/8S473J
	F6202 (F=450KHZ)		ATF1155		Other Resistors		RS1/10S□□□J
	L6107		ATH1043	<b>OTHERS</b>			
	L6209		LCTA221J3225		2P TERMINAL WITH PAL		AKA1017
	L6201, L6202, L6203, L6208		LCTA2R2J3225	X6203 (7.200MHZ)			ASS1042
<b>CAPACITORS</b>				X6201 (456kHZ)			ASS1066
	C6234, C6236, C6254, C6269		ACG1051	X6202 (450kHZ)		AM RF TUNING BLOCK	ATF1027
	C6235		ACG1052				AXX1041
	C6120		CCSCH060D50				
	C6229		CCSCH821J50				
	C6111		CCSQCH010C50				
	C6112, C6122		CCSQCH020C50				
	C6118		CCSQCH080D50				
	C6113, C6203		CCSQCH101J50				
	C6116, C6208, C6221, C6222		CCSQCH150J50				
	C6117		CCSQCH330J50				
	C6105		CCSQSL471J50				
	C6101		CCSQTH110J50				
	C6119		CCSQTH150J50				
	C6106, C6107		CCSQTH270J50				
	C6262		CEAS100M50				
	C6231, C6233		CEAS3R3M50				
	C6216, C6217		CEAS330M16				
	C6219		CEAS470M10				
	C6243, C6244, C6245		CEAS470M16				
	C6227		CEAS470M25				
	C6246		CEEA100M50				
	C6224		CEEA101M25				
	C6261		CEJA010M50				
	C6238		CEJA100M16				
	C6249, C6250		CEJA4R7M35				
	C6215		CFTXA103J50				
	C6214		CFTXA224J50				
	C6125, C6204, C6207		CKSQYB102K50				
	C6102, C6114, C6115, C6121, C6124		CKSQYB103K50				
	C6210, C6253, C6264		CKSQYB103K50				
	C6213		CKSQYB223K50				
	C6230		CKSQYB273K50				
	C6228		CKSQYB472K50				
	C6209, C6237		CKSQYB473K50				
	C6251, C6252		CKSQYB682K50				
	C6212, C6218		CKSQYF103Z50				
	C6220, C6226, C6239, C6242, C6255		CKSQYF223Z50				
	C6241		CKSQYF473Z50				
	C6123		CKSYB103K50				
	C6232		CKSYB273K50				
	C6223		CKSYF103Z50				
	C6263		CKSYF473Z50				
<b>RESISTORS</b>							
	VR6201 (10k)		ACP1056				
	VR6202		VRTB6VS223				
	R6299, R6300		RD1/8PM102J				
	R6115, R6119, R6123, R6127, R6268		RS1/8S000J				
	R6269-R6273, R6275, R6276, R6278		RS1/8S000J				
	R6283, R6284, R6289, R6290, R6293		RS1/8S000J				
	R6294, R6297, R6303		RS1/8S000J				
	R6243, R6244		RS1/8S101J				
	R6211		RS1/8S103J				
	R6247		RS1/8S152J				

## 5. ADJUSTMENTS

### ■ FM TUNER SECTION

- Set the mode selector to FM BAND.
- Connect the wiring as shown in Fig. 1.

Step No.	Adjustment Title	FM SG (1kHz, $\pm 75$ kHz dev.)		Reception Frequency Display	Adjustment Location	Specifications
		Frequency (MHz)	Level (dB $\mu$ V)			
1	Center Adjustment	98 Non modulation	80 or more	98MHz	L6207	Adjust so that the DC voltage between Pin 4 and Pin 28 (or $\oplus$ leads of C6224 and C6261) of IC6201 becomes $0V \pm 50mV$ .
2	Front End Sensitivity	98	10-30	98MHz	L6104 L6105*1 L6102 T6101	Adjust so that the DC voltage between Pin12 (or $\oplus$ leads of C6238) of IC6201 (S-meter) and GND becomes at maximum level.
3	TUNED IND. Lighting Level	98	$15 \pm 2$	98MHz	VR6201	Adjust so that the indicator of TUNED IND. starts to light up.
4	SK Level Adjustment	88 EXTERNAL *2 (RDS SG)	60	88MHz NORMAL (RF ATT ON)	VR901	Adjust so that the output level 57kHz between TP901 and GND becomes maximum.

\*1 : HEWZK type only

\*2 : RDS SG (AUDIO, PILOT, RDS, BK and DK: OFF, SK: ON)

Notes:

- Before adjusting, make sure there is no gap between L6101 and L6102. If there is a gap between them, bring them into contact with each other first, and then make adjustments.
- Make indicator adjustments in order of AM  $\rightarrow$  FM.

### ■ AM TUNER SECTION

- Set the mode selector to AM BAND.
- Connect the wiring as shown in Fig. 1.

Step No.	Adjustment Title	AM SG (400Hz, 30% Mod.)		Reception Frequency Display	Adjustment Location	Specifications
		Frequency (kHz)	Level (dB $\mu$ V/m)			
1	TUNED IND. Lighting Level	999	$47 \pm 2$	999kHz	VR6202	Adjust so that the indicator of TUNED IND. starts to light up.



**SX-403RDS, SX-303RDS, SX-203RDS**

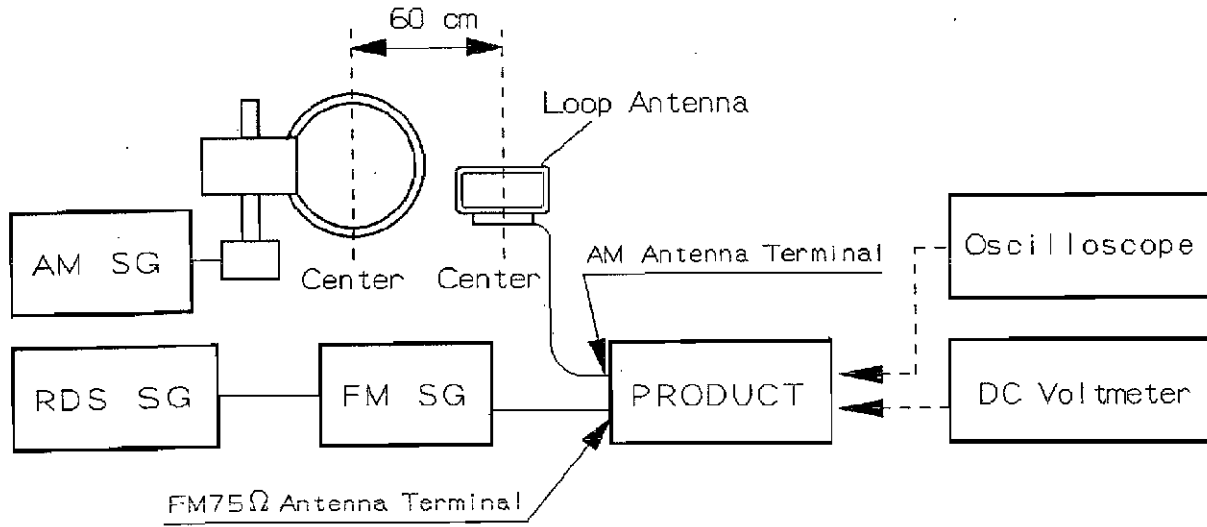
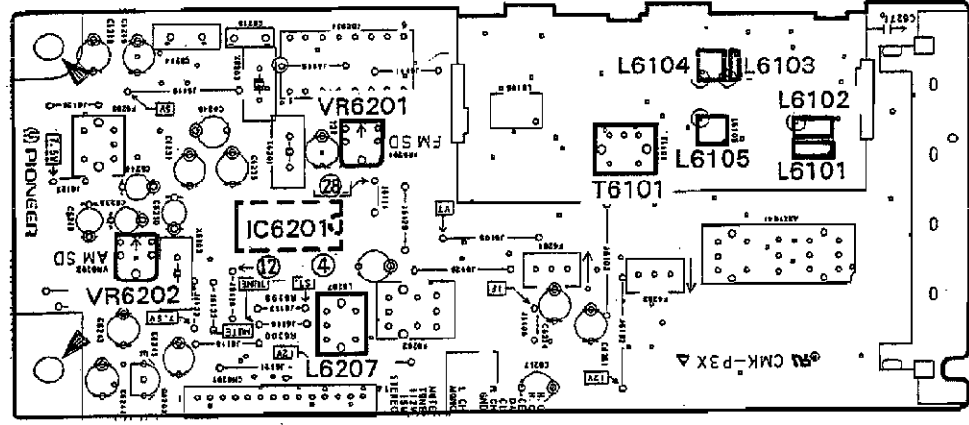

Fig. 1 FM and AM Adjustment Wiring Diagram

**FM/AM TUNER MODULE**



**RDS Assy**

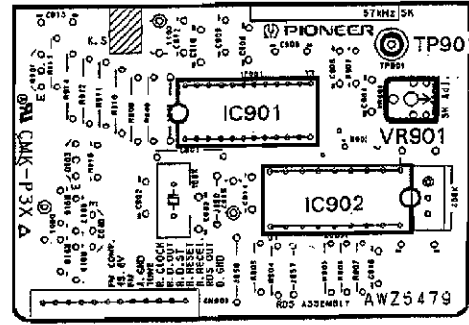
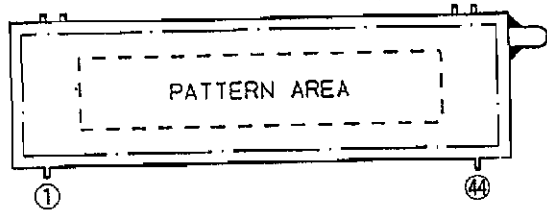

Fig. 2 Adjustment Points

## 6. FL INFORMATION

● AAV1195(V801)

PIN LOCATION



PIN CONNECTION

PIN NO.	1	2	3	4	5	6	7	8	9	10	11	12	13	14	15	16	17	18	19	20	21	22	23	24	25	26	27	28	29	30	31	32	33	34	35	36	37	38	39	40	41	42	43	44							
CONNECTION	F	F	N	N	0	9	8	7	6	5	4	3	2	1	N	N	2	2	2	2	2	2	2	2	2	2	2	2	2	2	2	2	2	2	2	2	2	2	2	2	2	2	2	2	2	2	2	2	2	2	2

- NOTE
- 1) F1, F2 --- Filament
  - 2) NP ----- No pin
  - 3) NC ----- No connection
  - 4) DL ----- Datum Line
  - 5) 1G~10G --- Grid

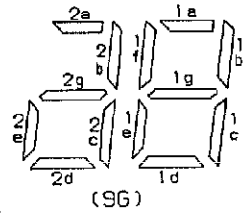
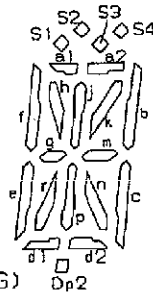

GRID ASSIGNMENT

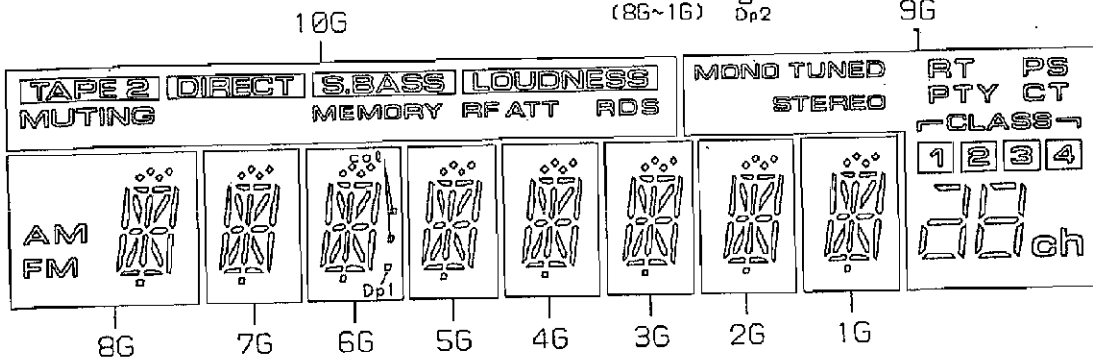

ANODE CONNECTION

	10G	9G	8G	7G	6G	5G	4G	3G	2G	1G
P1	-	TUNED	S1	S1	S1	S1	S1	S1	S1	S1
P2	-	STEREO	S2	S2	S2	S2	S2	S2	S2	S2
P3	-	2	S4	S4	S4	S4	S4	S4	S4	S4
P4	-	3	S3	S3	S3	S3	S3	S3	S3	S3
P5	MEMORY	MONO	a1	a1	a1	a1	a1	a1	a1	a1
P6	RFATT	4	a2	a2	a2	a2	a2	a2	a2	a2
P7	-	-CLASS-	h	h	h	h	h	h	h	h
P8	-	1	j	j	j	j	j	j	j	j
P9	TAPE 2	2b	b	b	b	b	b	b	b	b
P10	-	RT	k	k	k	k	k	k	k	k
P11	MUTING	1a	g	g	g	g	g	g	g	g
P12	LOUDNESS	1b	f	f	f	f	f	f	f	f
P13	-	2c	m	m	m	m	m	m	m	m
P14	-	CT	c	c	c	c	c	c	c	c
P15	-	PTY	p	p	p	p	p	p	p	p
P16	-	PS	r	r	r	r	r	r	r	r
P17	-	1g	n	n	n	n	n	n	n	n
P18	S.BASS	1e	d1	d1	d1	d1	d1	d1	d1	d1
P19	DIRECT	1c	e	e	e	e	e	e	e	e
P20	RDS	1d	d2	d2	d2	d2	d2	d2	d2	d2
P21	-	1f	Dp2	Dp2	Dp2	Dp2	Dp2	Dp2	Dp2	Dp2
P22	-	ch	AM	-	col	-	-	-	-	-
P23	-	2a, 2d, 2g	FM	-	Dp1	-	-	-	-	-
P24	-	2e	-	-	-	-	-	-	-	-



## 7. IC INFORMATION

- The information shown in the list is basic information and may not correspond exactly to that shown in the schematic diagrams.

### ■ PDG114A (IC801) CONTROL MICROCOMPUTER

#### ● Pin Function

No.	NAME	I/O	FUNCTION	ACT
1	RDS DATA	I	Data from LC7073 input	—
2	REMOCON	I	Remote control signal input	—
3	RDS DATA START	I	Synchronizing signal of each block from LC7073 input	—
4	RDS RESET	O	Reset signal output to LC7073 when receiving frequency converted	
5	FM	O	FM BAND select output	H
6	RF ATT	O	RF ATT ON/OFF output	H
7	MONO	O	FM MONO output	H
8	TUNE	I	TUNE indicator signal input	L
9	STEREO	I	STEREO indicator signal input	L
10	RDS RECEIVE	I	Signal showing RDS station or not input	L
11	DIRECT	O	DIRECT ON/OFF (Receiver only) *1	H
12	LW be or not	I	L: LW not being H: LW being (Tuner only) *1	—
13	LOUDNESS	O	LOUDNESS ON/OFF (Receiver only) *1	H
14	K10	I	KEYSCAN input 0	H
15	K11	I	KEYSCAN input 1	H
16	K12	I	KEYSCAN input 2	H
17	K13	I	KEYSCAN input 3	H
18	K14	I	KEYSCAN input 4	H
19	RECEIVER/ TUNER	I	Change-over of RECEIVER/ TUNER (L: Tuner H: Receiver)	—
20	K15	I	KEYSCAN input 5 (Receiver only) *1	H
21	K16	I	KEYSCAN input 6 (Receiver only) *1	H
22	REMOCON be or not	I	Change-over of destination (Receiver only) *1	H

No.	NAME	I/O	FUNCTION	ACT
23	NC		Not used	H
24	FUNCTION ST	O	Change-over of FUNCTION IC (TC9164N) Strobe (Receiver only) *1	
25	MUTE	O	TUNER, MUTE control output	H
26	VOL UP	O	VOLUME UP output	H
27	VOL DOWN	O	VOLUME DOWN output	H
28	Rotary input	O	Rotary encoder input A (Tuner only) *1	H
29	Rotary input	O	Rotary encoder input B (Tuner only) *1	H
30	RST	I	Reset input	
31	EX' TAL		Connecting 7.7 MHz oscillation crystal between pins	—
32	X' TAL			—
33	Vss		GND standard electric potential	—
34	NC		Not used	—
35	FL AC	O	FL AC ON/OFF	L
36	POWER	O	POWER ON/OFF	H
37	Seg 17	O	Segment indication output	H
38	Seg 18	O		
39	Seg 20	O		
40	Seg 19	O		
41	Seg 1	O		
42	Seg 2	O		
43	Seg 10	O		
44	Seg 11	O		
45	Seg 3	O		
46	Seg 12	O		
47	K00/S9	O	Segment indication output / KEYSCAN output	H

# SX-403RDS, SX-303RDS, SX-203RDS

No.	NAME	I/O	FUNCTION	ACT
48	K01/S8	O	Segment indication output / KEYSCAN output	H
49	K02/S13	O		
50	K03/S4	O		
51	K04/S15	O		
52	Seg 16	O	Segment indication output	H
53	Seg 14	O		
54	Seg 6	O		
55	Seg 7	O		
56	Seg 5	O		
57	Seg 21	O		
58	Seg 22	O	Segment Indication output (Receiver only) *1	H
59	Seg 23	O		
60	Seg 24	O		
61	R: G 1 T: G 10	O	Grid FL indication output	H
62	R: G 2 T: G 9	O		
63	R: G 3 T: G 8	O		
64	R: G 4 T: G 7	O		
65	R: G 5 T: G 6	O		
66	R: G 6 T: G 1	O		
67	R: G 7 T: G 2	O		
68	R: G 8 T: G 3	O		
69	R: G 9 T: G 4	O		
70	R: G 10 T: G 5	O		

No.	NAME	I/O	FUNCTION	ACT
71	-VFDP		Electric potential for FL display (-30 V)	—
72	VDD		+5 V Power source input	—
73	NC		+5 V Power source input	—
74	TEST	I	TEST MODE judgement input	H
75	PLL_DT	O	PLL communication data output (LM7001) and change-over function (TC9164N)	—
76	PLL_CK	O	PLL communication clock output (LM7001) and change-over function (TC9164N)	—
77	PLL_CE	O	PLL communication chip enable output (LM7001)	H
78	RDS_CK	I	Each bit from LC7073 synchronizing clock input	—
79	AC	I	WAKE • UP AC pulse input	—
80	RDS_OUT	I	Judging RDS signals output or not	L

\*1 : Functions will be changed according to setting (L or H) of Pin 19.



**SX-403RDS, SX-303RDS, SX-203RDS**

**AF ASSY (For SX-303RDS)**

AWZ5623, AWZ5487 and AWZ5484 have the same construction except for the following :

Mark	Symbol & Description	Part No.			Remarks
		AWZ5484	AWZ5623	AWZ5487	
△	RY751	ASR1044	ASR1027	ASR1044	
△	L751	.....	.....	ATF-151	
	L981-L984	.....	.....	ATH-133	
	C201, C202	.....	.....	CKPUYB181K50	
	C203-C210, C213-C224	.....	.....	CKPUYB391K50	
	C211, C212	.....	.....	CKPUYB821K50	
	C527, C528	.....	.....	CKPUYB331K50	
	C555, C556	.....	.....	CKDYB103K500	
	C981, C982	.....	.....	CKDYB471K50	
	C983, C984, C987, C988	.....	.....	CFTXA473J50	
	C985, C986	.....	.....	CKDYF103Z50	
	C991-C994	.....	.....	CCDSL560J50	
△	R211, R212	RD1/8PM331J	RD1/8PM331J	RD1/8PM102J	
	R563, R564	RD1/4PMF100J	RD1/4PMF100J	RD1/4PMF101J	
	R983, R984, R987, R988	.....	.....	RD1/4PMF100J	
	CN700 AC inlet (1P)	AKP1132	AKP1133	AKP1132	

**AF ASSY (For SX-203RDS)**

AWZ5622, AWZ5482 and AWZ5476 have the same construction except for the following :

Mark	Symbol & Description	Part No.			Remarks
		AWZ5476	AWZ5622	AWZ5482	
△	L751	.....	.....	ATF-151	
	L981-L984	.....	.....	ATH-133	
	C201, C202	.....	.....	CKPUYB181K50	
	C203-C210, C213-C224	.....	.....	CKPUYB391K50	
	C211, C212	.....	.....	CKPUYB821K50	
	C527, C528	.....	.....	CKPUYB331K50	
	C555, C556	.....	.....	CKDYB103K500	
	C981, C982	.....	.....	CKDYB471K50	
	C983, C984, C987, C988	.....	.....	CFTXA473J50	
	C985, C986	.....	.....	CKDYF103Z50	
	C991-C994	.....	.....	CCDSL560J50	
△	R211, R212	RD1/8PM331J	RD1/8PM331J	RD1/8PM102J	
	R563, R564	RD1/4PMF100J	RD1/4PMF100J	RD1/4PMF101J	
	R983, R984, R987, R988	.....	.....	RD1/4PMF100J	
	CN700 AC inlet (1P)	AKP1132	AKP1133	AKP1132	

# SX-403RDS, SX-303RDS, SX-203RDS

## FM/AM TUNER MODULE

AXQ3228 and AXQ3227 have the same construction except for the following :

Mark	Symbol & Description	Part No.		Remarks
		AXQ3227	AXQ3228	
Q6218		.....	2SC2712	
D6103		.....	1SV228	
F6205		.....	ATF1152	
L6105		.....	ATC1015	
L6205		.....	LCTA680J3225	
C6106		CCSQTH270J50	CCSQTH330J50	
C6107		CCSQTH270J50	CCSQTH300J50	
C6109		.....	CCSQTH270J50	
C6110		.....	CCSQTH300J50	
C6115		CKSQYB103K50	CKSQYB102K50	
C6122		CCSQCH020C50	CCSQCH010C50	
C6126		.....	CKSQYB102K50	
C6203		CCSQCH101J50	.....	
C6204		CKSQYB102K50	ACG1051	
C6229		CCSCH821J50	CCSCH102J50	
C6247		.....	CKSQYB122K50	
C6248		.....	CBEA100M50	
C6251, C6252		CKSQYB682K50	CKSQYB562K50	
C6256		.....	CKSQYF223Z50	
C6267		.....	CKSQYB473K50	
C6272		.....	CCSQL330J50	
R6114		.....	RS1/10S473J	
R6122		RS1/10S472J	RS1/10S332J	
R6129, R6302		.....	RS1/8S000J	
R6131, R6308		RS1/10S000J	.....	
R6232		.....	RS1/10S134J	
R6233		.....	RS1/10S513J	
R6234		.....	RS1/10S222J	
R6235		.....	RS1/10S132J	
R6236		.....	RS1/10S472J	
R6237		RS1/8S182J	RS1/8S122J	
R6238		RS1/10S182J	RS1/10S122J	
R6239		RS1/8S332J	RS1/8S103J	
R6240		RS1/10S332J	RS1/10S103J	
R6251		RS1/10S620J	RS1/10S680J	
R6290		RS1/8S000J	.....	

# SX-403RDS, SX-303RDS, SX-203RDS

## TRANS ASSY

AWZ5490 and AWZ5480 have the same construction except for the following :

Mark	Symbol & Description	Part No.		Remarks
		AWZ5480	AWZ5490	
C101		CQMXA103J100	CQMXA473J100	

## SP SW ASSY

AWZ5483 and AWZ5478 have the same construction except for the following :

Mark	Symbol & Description	Part No.		Remarks
		AWZ5478	AWZ5483	
C571, C572 C573, C574		.....	CKDYB222K50 CCDSL101J50	

## 9. PANEL FACILITIES

### 9.1 REAR PANEL FACILITIES

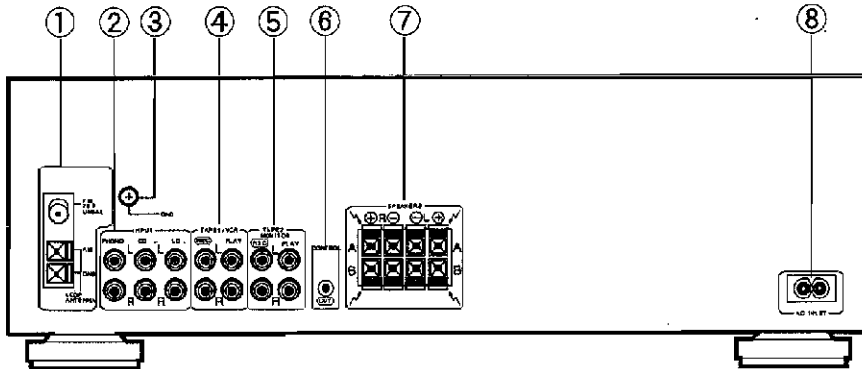

• The illustration shows SX-403RDS.

#### ① FM/AM ANTENNA terminals

Use these antenna terminals for receiving FM and AM broadcasts.

#### ② INPUT jacks

**PHONO** ..... Connect to the output cables from a turntable.  
**CD** ..... Connect to the output jacks of a compact disc player.  
**LD** ..... Connect to the output jacks of a LD player.

#### ③ GND terminal

Connect to the ground lead of a turntable.  
 Use a screwdriver to connect with the ground terminal.

#### ④ TAPE 1/VCR jacks

Connect these jacks to the cassette deck or video cassette recorder.

#### ⑤ TAPE 2 MONITOR jacks

Connect these jacks to the cassette deck.

#### ⑥ CONTROL OUT jacks (SX-403RDS and SX-303RDS)

Connect this jack to other Pioneer components bearing the **SR** mark when using the remote control of this unit to control the other components.

- ① To the CONTROL IN jack of other component.
- ② Receiver
- ③ Pioneer component bearing the **SR** mark.
- ④ Remote control unit.

#### ⑦ SPEAKERS terminals

**A:** Connect to a first set speakers.  
**B:** Connect to a second set of speakers.

#### NOTE:

No sound will be heard through the speakers when both A and B buttons are depressed if only one set of speakers has been connected to either A or B SPEAKERS terminals.

#### ⑧ AC INLET

Connect the power cord first to the unit, then plug it into the AC wall outlet.

## 9.2 FRONT PANEL FACILITIES

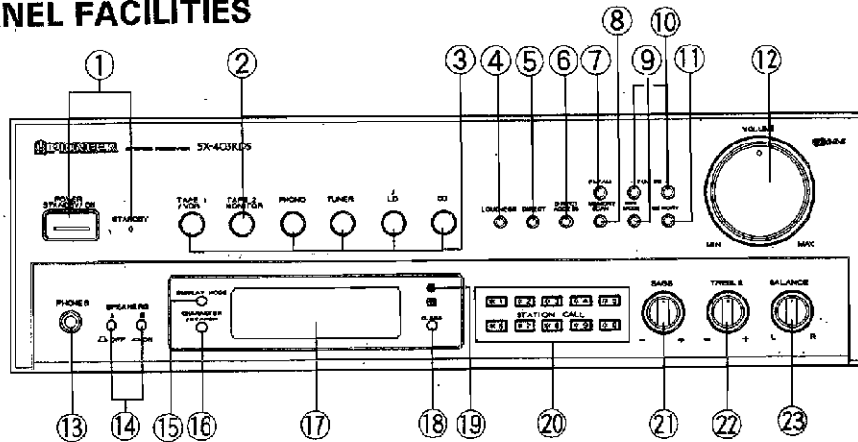

- The illustration shows SX-403RDS.

### ① POWER (STANDBY/ON) switch/STANDBY indicator (SX-403RDS, SX-303RDS)

This is the switch for electric power.

**ON:** When set to the ON position, power is supplied and the unit becomes operational.

**STANDBY:** When set to the STANDBY position, the main power flow is cut and the unit is no longer fully operational. A minute flow of power feeds the unit to maintain operation readiness.

- The accessory remote control unit can also be used to operate STANDBY/ON.

#### NOTE:

When the power is initially turned ON, muting will be applied to prevent sound from being output for approx. 5 seconds.

### ① POWER switch/indicator (SX-203RDS)

When this switch is pressed, the indicator showing power is being supplied lights up.

Press the switch again to turn power OFF.

[Timer ON/OFF possible]

When the unit is switched ON, ON/OFF control can be performed by means of the optional timer.

#### NOTE:

When the power is initially turned ON, muting will be applied to prevent sound from being output for approx 5 seconds.

### ② TAPE 2 MONITOR button

Press when listening to tape playback with the cassette deck 2.

### ③ Function buttons

Use to select playback source.

**[TAPE 1/VCR]** — Press when listening to tape playback with the cassette deck 1 or video cassette recorder.

**[PHONO]** — Press when listening to record playback on a turntable.

**[TUNER]** — Press when listening to AM or FM broadcasts with a tuner.

**[LD]** — Press when listening to laser disc with a laser disc player.

**[CD]** — Press when listening to compact disc playback with a CD player.

### ④ LOUDNESS button

Use when listening at low volume levels.

**ON:** Boosts low and high frequencies to produce a fuller sense of sound, particularly at low volume levels.

**OFF:** Normal position.

#### NOTE:

This button does not operate when the DIRECT button is in the ON position (SX-403RDS).

### ⑤ DIRECT button (SX-403RDS)

Use this button when you do not wish to pass the output from input terminal through the various frequency adjusting circuits (TREBLE, BASS and LOUDNESS). When this button is on, the BALANCE control does not operate.

### ⑤ RF ATT button (SX-303RDS/SX-203RDS)

Set this button to ON when receiving strong FM signals (near-by stations) to reduce sound distortion.

Normally, this button should be set to OFF.

This button has no effect on reception of AM broadcasts.

#### NOTE:

This button's status is preset for each station in station memory.

### ⑥ DIRECT ACCESS tuning button

When this button is pressed, the STATION CALL buttons function as ten-key number buttons for direct input of the desired reception frequency. Press again to cancel this mode.

### ⑦ FM/AM selector button

This button is used to select either AM or FM reception.

### ⑧ MEMORY SCAN button

This button is used for station memory scan.

MEMORY SCAN is not executed at the time of SLEEP timer operation.

### ⑨ MPX MODE selector button

Use to select the auto stereo mode or monaural mode when listening to FM broadcasts. The monaural mode has been selected when the FM MONO indicator is lighted.

#### Auto stereo mode:

Normally leave in this mode for reception. When a stereo FM broadcast is received, it will be automatically reproduced in stereo sound.

#### Monaural mode:

When receiving distant stations or stations with weak broadcast signals, the input signal may be weak, thus resulting in increased noise during FM stereo broadcasts. In this event, setting the receiver to the monaural mode will reduce the noise. In this case, however, FM stereo broadcasts will be reproduced in monaural sound.

#### NOTE:

This button has no effect on reception of AM broadcasts.



# SX-403RDS, SX-303RDS, SX-203RDS

## ⑩ TUNING buttons (-, +)

Use for tuning. Press the buttons to change the frequency display (3-speed Accel Tuning)

In the Manual Name input mode and PTY search mode, use to select characters and program types.

## ⑪ MEMORY button

When the unit is in the frequency display mode, pressing this button will result in the memorization of the current broadcast band, reception frequency, and FM AUTO/MONO mode.

### NOTE:

The MEMORY button does not function during SLEEP timer operation.

## ⑫ VOLUME control

Use to adjust volume level.

## ⑬ PHONES jack

Connect the plug on your headphones to this jack. To listen to a program through the headphones, set both SPEAKERS A and B switches to the OFF position.

## ⑭ SPEAKERS (OFF, ON) buttons

These are used to select the speaker through which you wish to listen.

A: When the speakers connected to A terminals are in use.

B: When the speakers connected to B terminals are in use.

- Turn both A and B speakers to OFF position when only the headphones are in use.

### NOTE:

No sound will be heard through the speakers when both A and B buttons are pressed if only one set of speakers has been connected to either A or B SPEAKERS terminals.

## ⑮ DISPLAY MODE button

Use only during FM reception. Use this to switch between display modes. Each time you press it, the display changes as follows.

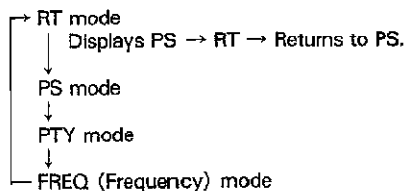

- This button does not function when the SLEEP button of the remote control unit is ON.

## ⑯ CHARACTER/SEARCH button

When receiving an AM broadcast, or when in the FM RT, PS modes: Press the button, "INPUT" is displayed, and the mode switches to manual station name input.

When in the FM PTY mode:

Press the button, "SEARCH" is displayed, and the mode switches to program type search.

- This button does not function when the SLEEP button of the remote control unit is ON. This button does not function at the time of frequency mode.

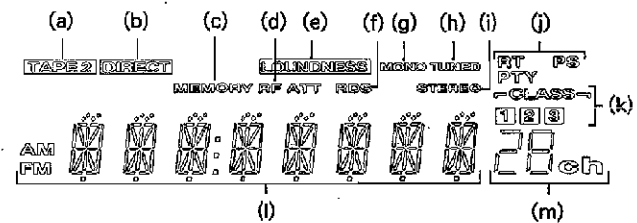

## ⑰ OPERATION DISPLAY panel

- (a) TAPE 2 monitor indicator
- (b) DIRECT indicator (SX-403RDS)
- (c) MEMORY indicator
- (d) RF ATT indicator
- (e) LOUDNESS indicator
- (f) RDS indicator
- (g) MONO indicator
- (h) TUNED indicator
- (i) STEREO indicator
- (j) RT, PS, PTY indicator
- (k) CLASS indicator
- (l) Frequency, function, character display
- (m) Channel display

## ⑱ CLASS button

Use to switch between preset memory classes 1 to 3. In each class, one station can be memorized in each of the 1 to 10 STATION CALL buttons, enabling a total of 30 stations to be memorized.

## ⑲ Remote sensor

## ⑳ STATION CALL buttons

These buttons are used to preset and recall desired broadcasting stations and direct access tuning.

## ㉑ BASS tone control

Use to adjust the low-frequency tone. The center position is the flat (normal) position. When tuned to the right, low-frequency tones are emphasized.

### NOTE:

This control does not operate when the DIRECT button is in the ON position. (SX-403RDS)

## ㉒ TREBLE tone control

Use to adjust high-frequency tone. The center position is the flat (normal) position. When tuned to the right, high-frequency tones are emphasized.

### NOTE:

This control does not operate when the DIRECT button is in the ON position. (SX-403RDS)

## ㉓ BALANCE control

Should normally be left in the center position. Adjust balance if the sound is louder from one of the speakers. If the right side is louder, turn toward the L position and if the left side is louder, turn toward the R position.

### NOTE:

This control does not operate when the DIRECT button is in the ON position. (SX-403RDS)

## 10. SPECIFICATIONS

### Amplifier Section

<b>Continuous Power Output (DIN)</b>	
(SX-403RDS) 1 kHz, T.H.D. 1%, 4 $\Omega$ .....	85 W + 85 W
(SX-303RDS) 1 kHz, T.H.D. 1%, 4 $\Omega$ .....	60 W + 60 W
(SX-203RDS) 1 kHz, T.H.D. 1%, 4 $\Omega$ .....	40 W + 40 W
<b>Continuous Power Output (both channel driven)*</b>	
(SX-403RDS) 20 Hz - 20 kHz, T.H.D. 0.07%, 8 $\Omega$ ...	80 W + 60 W
(SX-303RDS) 40 Hz - 20 kHz, T.H.D. 0.09%, 8 $\Omega$ ...	50 W + 50 W
(SX-203RDS) 40 Hz - 20 kHz, T.H.D. 0.09%, 8 $\Omega$ ...	35 W + 35 W
<b>Dynamic power output (with EIA test signal)</b>	
(SX-403RDS) 2/4/8 $\Omega$ .....	120 W/110 W/80 W
(SX-303RDS) 4/8 $\Omega$ .....	90 W/70 W
(SX-203RDS) 4/8 $\Omega$ .....	60 W/50 W
<b>Input (Sensitivity/Impedance)</b>	
PHONO .....	2.5 mV/47 k $\Omega$
CD, LD, TAPE 1/VCR, TAPE 2 .....	200 mV/22 k $\Omega$
<b>Phono Overload Level (T.H.D. 0.1%, 1 kHz)</b>	
PHONO .....	100 mV
<b>Output (Level/Impedance)</b>	
TAPE 1/VCR REC, TAPE 2 REC MONITOR .....	200 mV/2.2 k $\Omega$
<b>Frequency Response</b>	
PHONO (RIAA Equalization) .....	20 Hz to 20,000 Hz $\pm$ 0.5 dB
CD, LD, TAPE 1/VCR, TAPE 2 .....	10 Hz to 70,000 Hz $\pm$ 0.5 dB
<b>Signal-to-Noise Ratio (IHF, short circuited, A network)</b>	
(SX-403RDS),	
PHONO MM .....	81 dB
(SX-303RDS/SX-203RDS)	
PHONO .....	72 dB
(SX-403RDS)	
CD, LD, TAPE 1/VCR, TAPE 2 (DIRECT ON) .....	105 dB
TAPE 2 (DIRECT OFF) .....	100 dB
(SX-303RDS/SX-203RDS)	
CD, LD, TAPE 1/VCR, TAPE 2 .....	96 dB
<b>Tone control</b>	
BASS .....	$\pm$ 10 dB (100 Hz)
TREBLE .....	$\pm$ 10 dB (10 kHz)
LOUDNESS .....	+6 dB (100 Hz at -40dB)
	+4 dB (10 kHz at -40dB)

### FM Tuner Section

Frequency range .....	87.5 MHz to 108 MHz
Usable Sensitivity .....	14.2 dBf, IHF (1.4 $\mu$ V/75 $\Omega$ )
<b>Sensitivity (DIN)</b>	
MONO .....	1.0 $\mu$ V/75 $\Omega$
STEREO .....	50 $\mu$ V/75 $\Omega$
<b>Signal-to-Noise Ratio</b>	
MONO .....	74 dB (at 80 dBf)
STEREO .....	72 dB (at 80 dBf)
<b>Signal-to-Noise Ratio (DIN)</b>	
MONO .....	60 dB
STEREO .....	58 dB
<b>Distortion</b>	
STEREO .....	0.6% (1 kHz)
Alternate Channel Selectivity .....	65 dB (400 kHz)
Stereo Separation .....	40 dB (1 kHz)
Frequency Response .....	30 Hz to 15 kHz ( $\pm$ 1 dB)
Antenna Input .....	75 $\Omega$ unbalanced

### AM Tuner Section

Frequency range .....	531 kHz to 1,602 kHz
<b>Sensitivity</b>	
IHF, Loop antenna .....	350 $\mu$ V/m
Selectivity .....	25 dB
Signal-to-Noise Ratio .....	45 dB
Antenna .....	AM Loop Antenna

### Miscellaneous

Power Requirements .....	a.c. 220-230 Volts, 50 Hz
Power Consumption (SX-403RDS) .....	480 W
(SX-303RDS) .....	290 W
(SX-203RDS) .....	190 W
Dimensions .....	420 (W) X 140 (H) X 297.5 (D) mm
Weight (without package) (SX-403RDS) .....	6.8 kg
(SX-303RDS) .....	5.6 kg
(SX-203RDS) .....	4.9 kg

### Furnished Parts

FM Antenna .....	1
AM Loop Antenna .....	1
Remote control unit (except for SX-203RDS) .....	1
Dry cell batteries (size "AA" (R6P)) (except for SX-203RDS) .....	2
Power cord .....	1
Operating Instructions .....	1

### NOTE:

Specifications and design subject to possible modification without notice due to improvements.

\* Measured By Audio Spectrum Analyzer.